

AVO-9A-B, 200 mA, 4 ns pulse

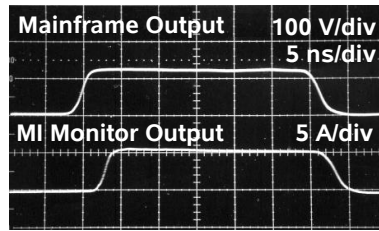

AVO-9P-B, 5A, 30 ns pulse

- ◆ IEEE-488.2 GPIB and RS-232 control (-B units)
- ◆ Peak currents from 100 mA to 32 Amps
- ◆ Pulse widths from 0.4 to 1 us, PRF to 25 MHz
- ◆ Rise times from 0.2 to 4 ns
- ◆ Simple socket mounting of laser diodes, which does not degrade rise times
- ◆ Double Pulse Options

The AVO-9 series offers a range of easy-to-use, ultra-high-speed pulsed laser diode drivers. Each model in the AVO-9 series consists of an instrument mainframe and an output module connected to the mainframe by a short coaxial cable. The mainframe generates a voltage pulse that is supplied to the output module. The output module has a special high-speed socket designed specifically for the user's packaged laser diode, and a series resistance. This arrangement provides a user-friendly "plug-and-play" setup, without degrading performance. Different output modules can be used if the user needs to drive more than one type of diode.

All models include a variant of the AVX-S1 output module (see www.avtechpulse.com/laser-bias/avx-s1) that provides a socket into which the user's laser diode is inserted. Avtech can customize the sockets for many packages - for example, 14-pin butterfly, 5.6 mm can, 9 mm can, TO-3, and others. (The laser diodes are *not* supplied with the AVO-9 series). The output module connects to the instrument mainframe using one or two detachable coaxial cables.

The output module contains the necessary elements to match the laser diode to the pulse generator mainframe. Output modules may be interchanged to accommodate different diode packages or different pin connections. A forward DC bias current of up to 100 mA may be applied to the laser diode by applying the desired DC current to a solder terminal on the output module. The output modules include "MV" and "MI" SMA outputs for sensing the voltage and current of the laser diode. (Due to the parasitic inductance in the sensing elements, the MV and MI outputs are not necessarily accurate representations of the electrical waveform shape. These outputs tend to show high overshoot on the rising and falling edges, as a measurement artifact. These outputs are primarily for estimating the current or voltage amplitudes.)

An optional low-bandwidth SMA connection to a photo diode detector output is also available (-MD option). See the AVX-S1 datasheet at <http://www.avtechpulse.com/laser-bias/avx-s1> for more details.

At time of ordering, the customer must specify the basic model series and desired options (e.g. AVO-9A-C-P-MD), and the customer should email Avtech (info@avtechpulse.com) a copy of the diode datasheet so that we can confirm the electrical and mechanical design of the diode. Every output module is customized to accept a particular diode pinout. If the user wishes to test more than one diode, several output modules may be needed. Pricing depends on the mechanical complexity of the output module(s).

The polarity of the pulse supplied to the output module may be changed by adding a pulse transformer (typically the AVX-3, see <http://www.avtechpulse.com/transformer/avx-3>) between the mainframe and the output module. In addition, the output modules may be detached from the mainframe and used with other pulse or CW drivers. A more detailed description of the output module is given on the AVX-S1 datasheet (available at <http://www.avtechpulse.com/laser-bias/avx-s1>).

The mainframes are slightly modified versions of standard Avtech pulse generators, as noted in the specification table. If desired, the mainframes may be used (without the output modules) to drive a resistive load directly.

When using the output module, the pulse current through the diode load is given by:

$$I_{\text{DIODE}} = ((V_{\text{MAINFRAME}} / N) - V_{\text{DIODE}}) \div (R_S + R_{\text{DIODE}})$$

where $V_{\text{MAINFRAME}}$ is the output voltage of the mainframe, V_{DIODE} is the diode voltage, R_{DIODE} is the diode parasitic resistance, R_S is the fixed series resistance built into the output module, and N is the current-boosting ratio of the transformer in the module (if present). The minimum useful amplitude is typically 20% of the maximum amplitude. User-supplied external attenuators can normally be installed between the mainframe and the output module to reduce the effective value of $V_{\text{MAINFRAME}}$.

$R_S + R_{\text{DIODE}}$ is selected to provide a proper transmission line termination for the coaxial cabling. For the low-current models (below 2 Amps), $N = 1$ and $R_S + R_{\text{DIODE}} \approx 50\Omega$. Some higher-current models use the same arrangement, but others use a combination of current-boosting transformers (with $N = 2$ or 4) and/or multiple coaxial cables in parallel to match $R_S + R_{\text{DIODE}}$ values of 12.5, 6.2, or 3.1 Ohms.

R_{DIODE} is determined by the user's diode. Many laser diodes have minimal parasitic resistance, and $R_{\text{DIODE}} \approx 0$. (Some laser diodes have a discrete resistance added internally - some have $R_{\text{DIODE}} \approx 25\Omega$. These lasers can only be used with the drivers that require $R_S + R_{\text{DIODE}} \approx 50\Omega$.) R_{SERIES} is adjusted by Avtech for each instrument so that the correct $R_S + R_{\text{DIODE}}$ total is obtained. These models are intended for diode loads whose forward voltage drop is $\leq 3V$. The maximum obtainable current will decrease if the diode voltage is higher than this.

Some models are available with a "-DP" option which permits the generation of double-pulse (doublet) waveforms. The -DP option provides a burst of two same-polarity output pulses on a common output with a variable time separation of 0 to ± 50 ns for -C units, and 0 to +50% of the period (period = 1 / pulse repetition frequency) for -B units. Other delay ranges can be provided upon request. Two independent pulse width and amplitude controls are provided. Units with the -DP option have a maximum output amplitude of 70% of the standard maximum amplitude (except when the relative time delay is set to zero, in which case the addition of the two coincident pulses allows the 140% of the standard amplitude to be obtained).

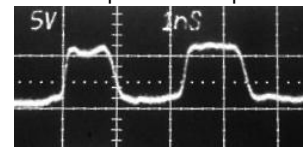

The AVO-9A, -9A3, -9A4, -9A5, -9B, -9B1 & -9B2 families offer maximum currents of 200, 400, 800 or 1000 mA, with very fast switching times and moderate repetition rates. The AVO-9A provides up to 200 mA, narrow pulse widths of 0.4 to 4 ns, rise times of 200 ps, and pulse repetition frequencies (PRF) to 1 MHz. The AVO-9B series is similar, but with wider pulses of 5 to 100 ns. The AVO-9B1 offers a much wider pulse width range of 0.5 to 1000 ns, with slightly slower 250 ps rise times. The 400 mA AVO-9B2 family also offers a wide pulse width range (0.6 - 1000 ns), with 350 ps rise times and a maximum PRF of 100 kHz. The 800 mA AVO-9A3-B features a 0.4 to 2.0 ns (optionally 0.4 to 4.0 ns) pulse width range and PRF to 1 MHz. The similar AVO-9A4 operates from 1-10 ns up to 150 kHz. Model AVO-9A5 operates from 1-10 ns up to 1 MHz, at amplitudes up to 1 Amp, with 500 ps rise times.

The AVO-9C, -9E, and -9R families are designed for operation at higher frequencies. The AVO-9C family offers 100 mA amplitude, 0.5 to 10 ns pulse widths, 300 ps rise times, and frequencies of 10 kHz to 25 MHz. The AVO-9E family offers amplitudes to 400 or 800 mA, 10 to 200 ns pulse widths, 300 ps rise times, and a PRF up to 10 MHz.

The AVO-9G, -9H, 9H1, -9H2, -9L, -9M, -9P, -9W, -9X, -9Y, -9Z families offer higher maximum currents (1-32A). Sub-nanosecond rise times are available for currents up to 4.5 Amps. Repetition rates up to 2 MHz are possible.

Instruments with the -B suffix include a complete computer control interface (see <http://www.avtechpulse.com/gpib> for details). This provides GPIB and RS-232 computer-control, as well as front panel keypad and adjust knob control of the output pulse parameters. A large backlit LCD displays the output amplitude, frequency, pulse width, and delay. To allow easy integration into automated test systems, the programming command set is based on the SCPI standard, and LabView drivers are available for download at the Avtech web site (<http://www.avtechpulse.com/labview>).

The -VXI option adds a rear-panel Ethernet connector, allowing an instrument to be remotely controlled using the VXI-11.3, ssh, telnet, and web protocols. In particular, the VXI-11.3 features allows software like LabView to control an instrument

using standard VISA communications drivers and network cabling, instead of using older-style GPIB cabling and GPIB controller cards. See <http://www.avtechpulse.com/options/vxi>.

The -C versions provide outputs similar to those of the -B models, but do not include the GPIB or RS-232 interfaces or LCD display. The output parameters are controlled by front-panel range switches and one-turn vernier controls.

All models may be triggered externally using a TTL-level pulse, and include a delay control and sync output for oscilloscope triggering.

Most other Avtech high-speed pulse generators can be supplied with output modules for use with laser diodes, in a style similar to the AVO-9 series. Many aspects of the AVO-9 series can be adapted readily for particular applications. Some models can be provided in a customized DC-powered externally-triggered OEM-style module format. Contact Avtech (info@avtechpulse.com) with your special requirements!

A parametric search engine is available online at <http://www.avtechpulse.com/pick> to assist you in selecting the best instrument for your application. You can also speak directly to an engineer at Avtech – call us.

<http://www.avtechpulse.com/appnote/vendors> provides a list of possible sources of laser diodes for use with the AVO-9 series. Avtech does not sell laser diodes.

COMMON PACKAGES THAT CAN BE ACCOMODATED

For butterfly devices, Avtech can provide output modules that either mate to just one side of the package (the side with the anode and cathode), or to both sides of the package (to permit access to the thermoelectric cooler and thermistor pins).

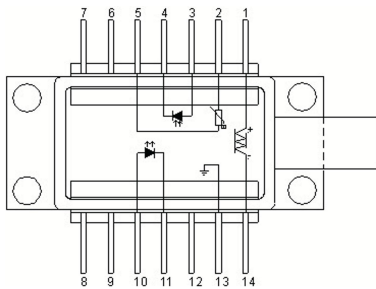

-P1B / -T1B Package Options, for butterfly packages with the anode on pin 10 and the cathode on pin 11. The -P1B option provides high-speed pin sockets for pins 8-14. To include a low-bandwidth slide-on socket for pins 1-7, add the -T1B option.

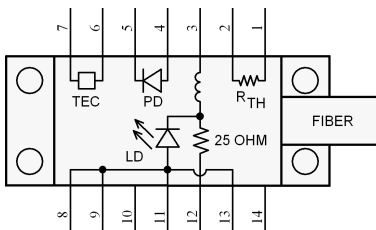

-P1C / -T1C Package Options, for butterfly packages with the anode on pin 11 and the cathode on pin 12, and an internal series resistance of ≈ 25 Ohms. The -P1C option provides high-speed pin sockets for pins 8-14. To specify an additional low-bandwidth slide-on socket for pins 1-7, add the -T1C option. If the internal resistance is 0 Ohms, use the -P1CR0 suffix instead.

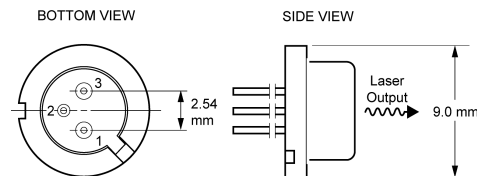

-P0 Option, generic* 5.6mm or 9 mm Package with 2.54mm pin circle diameter (PCD)

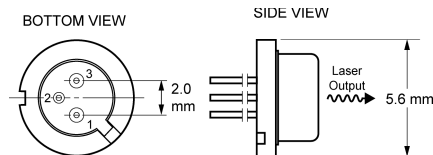

-P2 Option, generic* 5.6 mm Package with 2.0mm pin circle diameter (PCD)

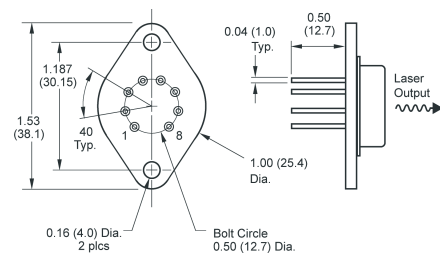

-TO3 Option, generic* TO-3 Package

* Additional details (pinout, diode resistance) must be supplied by the end-user if this option is specified.

Other packages can be accommodated. Contact Avtech with your special requirement!

OUTPUT MODULE SPECIFICATIONS / PINOUTS

Each model is customized for a specific diode's pinout and I-V characteristics. If a generic pinout option (e.g., -P0, -P1, -P2, -P3, -TO3) is selected, then a drawing showing the diode package size and electrical pinout must be provided by the end-user, and the model number and price may change. If a specific pinout option has been selected (-P1B or -P1C, for instance - see above), no additional information is required.

If you have selected the basic pulser that you need (for instance, the AVO-9A-B), but are confused about the mechanical specifications, simply email the diode datasheet to Avtech (info@avtechpulse.com) and we will provide you with the most appropriate complete model number (customized, if required).



SPECIFICATIONS

AVO-9 SERIES

Models ≤ 1 Amp, with PRF ≤ 1.0 MHz

Model ¹ :	AVO-9A-B	AVO-9B-B	AVO-9B1-B	AVO-9B2-B	AVO-9A3-B	AVO-9A4-B	AVO-9A5-B
Maximum amplitude ² :	200 mA		200 mA	400 mA	800 mA		1 Amp
Max. output of mainframe into 50Ω (V _{MAINFRAME}):	13V		13V	23V	43V		53V
R _S + R _{DIODE} :	50Ω						
Transformer ratio, N:	1						
Allowed load voltage range:	0 to 3V. (Contact Avtech if your diode has a higher forward voltage drop)						
Pulse width (FWHM):	0.4 - 4 ns	5 - 100 ns	0.5 - 1000 ns	0.6 - 1000 ns	0.4 - 2 ns std, 0.4 - 4 ns opt ⁷	1 - 10 ns	1 - 10 ns
Maximum duty cycle:	N/A		5%		NA		
Maximum PRF ⁸ :	1 MHz		1 MHz	100 kHz	1 MHz	150 kHz	1 MHz
Rise times (20%-80%):	≤ 200 ps		≤ 250 ps	≤ 350 ps	≤ 200 ps	≤ 500 ps	≤ 500 ps
Fall times (80%-20%):	≤ 200 ps		≤ 250 ps	≤ 350 ps	≤ 300 ps ⁷	≤ 750 ps	≤ 1 ns
Related 50Ω series:	AVP-AV-1	AVMP-2	AVPP-1A	AVPP-2A	AVP-AV-HV3	AVI-V-2L	AVR-E5
Included output module:	AVX-S1						
Polarity ³ :	Positive or negative (specify)						
GPIB and RS-232 control ¹ :	Standard on -B units.						
LabView drivers:	Check http://www.avtechpulse.com/labview for availability and downloads						
Ethernet port, for remote control using VXI-11.3, ssh, telnet, & web:	Optional ⁴ . Recommended as a modern alternative to GPIB / RS-232. See http://www.avtechpulse.com/options/vxi for details.						
Double pulse separation: (option ⁵)	0 to +50% of the period	Not available			0 to +50% of the period	NA	
Propagation delay:	≤ 150 ns (Ext trig in to pulse out)						
Jitter:	± 35 ps ± 0.015% of sync delay (Ext trig in to pulse out)						
DC offset or bias insertion:	Apply required DC bias current in the range of ± 100 mA to solder terminal on output module.						
Sync delay:	Variable 0 to 200 ns (±1 second for -B units), sync out to pulse out						
Sync output (to 50Ω):	+3V, 100 ns						
Gate input:	Synchronous or asynchronous, active high or low, switchable. Suppresses triggering when active.						
Trigger required:	Ext trig mode: +5 V (TTL), ≥ 50 ns						
Monitor output option ⁶ :	Provides connection to output of photo diode detector.						
Connectors: Out: Other:	User-specified socket. Sockets can be provided for 5.6 mm, 9 mm, butterfly, and other packages. Trig, Sync, Gate: BNC, Monitor: SMA						
Recommended accessory kit:	Add the suffix "-AK1" to the model number to include the recommended accessory kit. Consists of three SMA, 18 GHz, 2 Watt attenuators (10, 20 & 30 dB) for use on the output, and two 50 Ohm, 1 GHz, 1 Watt feed-through terminators (one SMA, one BNC) for use on external trigger inputs.						
Power requirements:	100 - 240 Volts, 50 - 60 Hz						
Dimensions, Mainframe: (H×W×D)	100 x 430 x 375 mm (3.9" x 17" x 14.8"). Anodized aluminum, with blue plastic trim.						
Dimensions, Output Module:	41 x 66 x 76 mm (1.6" x 2.6" x 3.0"), cast aluminum, blue enamel						
Temperature range:	+5°C to +40°C						

- 1) -B suffix indicates IEEE-488.2 GPIB and RS-232 control of amplitude and frequency. See <http://www.avtechpulse.com/gpib/> for details.
- 2) For operation at amplitudes of less than 20% of full-scale, best results will be obtained by setting the amplitude near full-scale and using external attenuators on the output, between the mainframe and the output module. Attenuators are available in the -AK1 accessory kit option.
- 3) Indicate desired polarity by suffixing model number with -P or -N.
- 4) Add the suffix -VXI to the model number to specify the Ethernet port.

- 5) For the double pulse option, add the suffix -DP. This option causes the maximum amplitude to be reduced by 30%.
- 6) For photo diode output monitor option add suffix -MD.
- 7) For 0.4 to 4.0 pulse width, suffix model number with -W4. Fall time specification increases to 450 ps for units with the -W4 option.
- 8) The minimum PRF of the internal oscillator is 1 Hz on -B units. In the external trigger mode, the minimum frequency is 0 Hz.

Models < 1 Amp, with PRF > 1 MHz

Model:	AVO-9E-B ²	AVO-9RA-C ¹ AVO-9RA-B ²	AVO-9C-C ¹	AVO-9R-C ¹
Maximum amplitude ^{3,6} :	400 mA	340 mA	100 mA	250 mA
Max. output of mainframe into 50Ω (V _{MAINFRAME}):	23V	20V	8V	15V
R _S + R _{DIODE} :	50Ω			
Transformer ratio, N:	1			
Allowed load voltage range:	0 to 3V. (Contact Avtech if your diode has a higher forward voltage drop)			
Pulse width (FWHM) ⁶ :	10 - 200 ns	0.5 - 4 ns	0.5 - 10 ns	0.4 - 2 ns ⁹
Maximum duty cycle:	10%	N/A	N/A	N/A
Minimum PRF:	1 Hz	3 kHz	10 kHz	3 kHz
Maximum PRF:	10 MHz		25 MHz	
Rise time (20%-80%):	≤ 300 ps	250 ps	300 ps	≤ 200 ps
Fall time (80%-20%):	≤ 300 ps	300 ps	600 ps	≤ 250 ps
Related 50Ω series:	AVMR-2A	AVM-4	AVMM-2	AVM-2
Included output module:	AVX-S1			
Polarity ⁴ :	Positive or negative, (specify)			
GPIB and RS-232 control ² :	Standard on -B units. Not available on -C units.			
LabView drivers:	-B units only: check http://www.avtechpulse.com/labview for availability and downloads			
Ethernet port, for remote control using VXI-11.3, ssh, telnet, & web:	Optional ⁷ for -B units. Recommended as a modern alternative to GPIB / RS-232. See http://www.avtechpulse.com/options/vxi for details.			
Double pulse option:	Not available			
Propagation delay:	< 150 ns (Ext trig in to pulse out)			
Jitter (Ext trig in to pulse out):	-B units: ± 35 ps ± 0.015% of sync delay. -C units: ± 15 ps			
DC offset or bias insertion:	Apply required DC bias current in the range of ± 100 mA to solder terminal on output module.			
Sync delay: (Sync out to pulse out):	-B units: 0 to ±1 sec, variable -C units: 0 to 85 ns, variable			
Sync output (to 50Ω):	-B units: +3V, 100 ns, will drive 50 Ohms. -C units: Approximately 20 ns wide and 0.5V in amplitude. Logically complemented (i.e., LOW ≈ +0.5V, High ≈ 0V). Will drive 50 Ohms.			
Trigger required ⁸ : (External trigger mode)	TTL-level pulse (LOW = 0V, High = +3 to +5V), ≥ 10 ns or wider, ≥ 1kΩ input impedance			
Monitor output option ⁵ :	Provides a connection to output of the photodiode detector (if present in the device under test).			
Connectors: Out: Other:	User-specified socket. Sockets can be provided for 5.6 mm, 9 mm, butterfly, and other packages. Trig / Sync: BNC, Monitor: SMA			
Recommended accessory kit:	Add the suffix "-AK1" to the model number to include the recommended accessory kit. Consists of three SMA, 18 GHz, 2 Watt attenuators (10, 20 & 30 dB) for use on the output, and two 50 Ohm, 1 GHz, 1 Watt feed-through terminators (one SMA, one BNC) for use on external trigger inputs.			
Power requirements:	100 - 240 Volts, 50 - 60 Hz			
Dimensions (H×W×D):	Mainframe: 100 x 430 x 375 mm (3.9" x 17" x 14.8") Output module: 42 x 67 x 76 mm (1.6" x 2.6" x 3.0"),			
Temperature range:	+5°C to +40°C			

- 1) -C suffix indicates stand-alone lab instrument with internal clock and line powering. (See <http://www.avtechpulse.com/formats/> for details of the instrument formats).
- 2) -B suffix indicates IEEE-488.2 GPIB and RS-232 control of amplitude and frequency. See <http://www.avtechpulse.com/gpib/> for details.
- 3) For operation at amplitudes of less than 20% of full-scale, best results will be obtained by setting the amplitude near full-scale and using external attenuators on the output, between the mainframe and the output module. Attenuators are available in the -AK1 accessory kit option.
- 4) Indicate desired polarity by suffixing model number with -P or -N.
- 5) For photo diode output monitor option add suffix -MD.

- 6) For electronic control (0 to +10V) of amplitude or pulse width, suffix the model number with -EA or -EW. Electronic control units also include the standard front panel one-turn controls. Only available on the -9R, -9RA, and -9C models.
- 7) Add the suffix -VXI to the model number to specify the Ethernet port.
- 8) These models are not suitable for non-repetitive or random triggering. Internal time constants and settling periods may cause unexpected results with aperiodic trigger signals.
- 9) The PRF / PW / amplitude controls on this model tend to interact. Not suitable for automated test applications.



SPECIFICATIONS

AVO-9 SERIES

1 & 2 Amp Models

Model ¹ :	AVO-9G-B	AVO-9H-B	AVO-9H1-B	AVO-9H2-B	AVO-9L-B
Maximum amplitude ² :	1 Amp	2 Amp	2 Amp	2 Amp	2 Amp
Maximum voltage output of mainframe (V _{MAINFRAME}):	53V (to 50Ω)	103V (to 50Ω)	103V (to 50Ω)	103V (to 50Ω)	50V (to 50Ω)
R _s + R _{DIODE} :	50Ω	50Ω	50Ω	50Ω	12.5Ω
Transformer ratio, N:	1	1	1	1	2
Allowed load voltage range:	0 to 3V. (Contact Avtech if your diode has a higher forward voltage drop)				
Pulse width (FWHM):	Standard: 10 - 200 ns -W1 option: 1 - 200 ns		10 - 500 ns	8 - 30 ns	1 - 20 ns
Maximum duty cycle:	N/A		2%	N/A	
Maximum PRF ⁹ :	100 kHz	50 kHz	200 kHz	2 MHz	100 kHz
Rise time (20%-80%):	≤ 0.5 ns	≤ 0.7 ns	≤ 1.2 ns	≤ 2.0 ns	≤ 500 ps
Fall time (20%-80%):	≤ 1.0 ns	≤ 1.0 ns	≤ 2.0 ns ⁶	≤ 2.0 ns	≤ 500 ps
Related 50Ω series:	AVR-E2	AVR-E3	AVR-E3A	AVR-E6	AVO-2L
Included output module:	AVX-S2	AVX-S2	AVX-S2	AVX-S2	AVX-S1-HC
Polarity ³ :	Positive or negative (specify)				
GPIB and RS-232 control ¹ :	Standard on -B units.				
LabView drivers:	-B units only; check http://www.avtechpulse.com/labview for availability and downloads				
Ethernet port, for remote control using VXI-11.3, ssh, telnet, & web:	Optional ⁴ . Recommended as a modern alternative to GPIB / RS-232. See http://www.avtechpulse.com/options/vxi for details.				
Double pulse separation: (option ⁷)	Not available.			0 to +50% of the period	
Propagation delay:	≤ 150 ns (Ext trig in to pulse out)				
Jitter:	± 35 ps ± 0.015% of sync delay (Ext trig in to pulse out)				
DC offset or bias insertion:	Apply required DC bias current in the range of ± 100 mA to solder terminal on output module.				
Sync delay:	Variable 0 to ±1 second, sync out to pulse out				
Sync output:	+ 3 Volts, 100 ns, will drive 50 Ohms				
Gate input:	Synchronous or asynchronous, active high or low, switchable. Suppresses triggering when active.				
Trigger required:	External trigger mode: TTL-level pulse (LO = 0V, HI = 3-5V), ≥ 10 ns				
Photodiode output option ⁵ :	Provides connection to output of photo diode detector. (Requires a photodiode in the device under test.)				
Connectors: Out: Other:	User-specified socket. Sockets can be provided for 5.6 mm, 9 mm, butterfly, and other packages. Trig, Sync, Gate: BNC, Monitor: SMA				
Recommended accessory kit:	Add the suffix "-AK2" to the model number to include the recommended accessory kit. Consists of one SMA 12 GHz 20 Watt attenuator (20 dB) and two SMA 18 GHz 2 Watt attenuators (10 & 20 dB) for use on the output, and two 50 Ohm, 1 GHz, 1 Watt feed-through terminators (one SMA, one BNC) for use on external trigger inputs.				
Power requirements:	100 - 240 Volts, 50 - 60 Hz				
Dimensions: Mainframe: (H×W×D) Output module:	100 x 430 x 375 mm (3.9" x 17" x 14.8") , anodized aluminum, with blue plastic trim 41 x 66 x 76 mm (1.6" x 2.6" x 3.0") , cast aluminum, blue enamel				
Temperature range:	+5°C to +40°C				

- 1) -B suffix indicates IEEE-488.2 GPIB and RS-232 control of amplitude and frequency. See <http://www.avtechpulse.com/gpib/> for details.
- 2) For operation at amplitudes of less than 20% of full-scale, best results will be obtained by setting the amplitude near full-scale and using external attenuators on the output, between the mainframe and the output module. Attenuators are available in the -AK1 accessory kit option.
- 3) Indicate desired polarity by suffixing model number with -P or -N (i.e. positive or negative).

- 4) Add the suffix -VXI to the model number to specify the Ethernet port.
- 5) For photo diode output monitor option add suffix -MD.
- 6) Fall time increases to < 3 ns for pulse widths less than 15 ns.
- 7) For the double pulse option, add the suffix -DP. This option causes the maximum amplitude to be reduced by 30%.
- 9) The minimum PRF of the internal oscillator is 1 Hz on -B units. For -C units, it is 1/10000th of the maximum PRF.

≥ 2 Amp Models

Model ¹ :	AVO-9M-B	AVO-9P-B	AVO-9W-B	AVO-9X-B	AVO-9Y-B	AVO-9Z-B
Maximum amplitude ^{2,6,7} :	4.5 Amp	5 Amp	10 Amp	8A	16A	32A
Maximum voltage output of mainframe (V _{MAINFRAME}):	125V (to 50Ω)	125V (to 50Ω)	125V (to 25Ω)	400V (to 50Ω)		
R _S + R _{DIODE} :	10Ω	12.5Ω	6.2Ω	50Ω	12.5Ω	3.1Ω
Transformer ratio, N:	2	2	2	1	2	4
Allowed load voltage range:	0 to 3V. (Contact Avtech if your diode has a higher forward voltage drop)					
Pulse width (FWHM):	1 - 10 ns	4 - 50 ns		8 - 100 ns		
Maximum duty cycle:	N/A					
Maximum PRF ⁹ :	20 kHz	40 kHz	20 kHz	2 kHz		
Rise time (20%-80%):	≤ 1 ns	≤ 2.5 ns		≤ 4 ns standard, ≤ 2 ns optional ⁶		
Fall time (20%-80%):	≤ 1 ns	≤ 3.5 ns		≤ 5 ns		
Related 50Ω series:	AVO-2M	AVO-2A	AVO-2W	AVL-5		
Included output module:	AVX-S3A	AVX-S3A	AVX-S3C	P/N TBD		
Polarity ³ :	Positive or negative (specify)					
GPiB and RS-232 control ¹ :	Standard on -B units.					
LabView drivers:	-B units only: check http://www.avtechpulse.com/labview for availability and downloads					
Ethernet port, for remote control using VXI-11.3, ssh, telnet, & web:	Optional ⁴ . Recommended as a modern alternative to GPiB / RS-232. See http://www.avtechpulse.com/options/vxi for details.					
Double pulse separation: (option ⁷)	0 to +50% of the period	Not available.				
Propagation delay:	≤ 150 ns (Ext trig in to pulse out)					
Jitter:	± 35 ps ± 0.015% of sync delay (Ext trig in to pulse out)					
DC offset or bias insertion:	Apply required DC bias current in the range of ± 100 mA to solder terminal on output module.					
Sync delay:	Variable 0 to ±1 second, sync out to pulse out					
Sync output:	+ 3 Volts, 100 ns, will drive 50 Ohms					
Gate input:	Synchronous or asynchronous, active high or low, switchable. Suppresses triggering when active.					
Trigger required:	External trigger mode: TTL-level pulse (LO = 0V, HI = 3-5V), ≥ 10 ns					
Photodiode output option ⁵ :	Provides connection to output of photo diode detector. (Requires a photodiode in the device under test.)					
Connectors: Out: Other:	User-specified socket. Sockets can be provided for 5.6 mm, 9 mm, butterfly, and other packages. Trig, Sync, Gate: BNC, Monitor: SMA					
Recommended accessory kit:	Add the suffix "-AK2" to the model number to include the recommended accessory kit. Consists of one SMA 12 GHz 20 Watt attenuator (20 dB) and two SMA 18 GHz 2 Watt attenuators (10 & 20 dB) for use on the output, and two 50 Ohm, 1 GHz, 1 Watt feed-through terminators (one SMA, one BNC) for use on external trigger inputs.					
Power requirements:	100 - 240 Volts, 50 - 60 Hz					
Dimensions: Mainframe: (H×W×D) Output module:	100 x 430 x 375 mm (3.9" x 17" x 14.8") , anodized aluminum, with blue plastic trim 41 x 66 x 76 mm (1.6" x 2.6" x 3.0") , cast aluminum, blue enamel					
Temperature range:	+5°C to +40°C					

- B suffix indicates IEEE-488.2 GPiB and RS-232 control of amplitude and frequency. See <http://www.avtechpulse.com/gpib/> for details.
- For operation at amplitudes of less than 20% of full-scale, best results will be obtained by setting the amplitude near full-scale and using external attenuators on the output, between the mainframe and the output module.
- Indicate desired polarity by suffixing model number with -P or -N (i.e. positive or negative).

- Add the suffix -VXI to the model number to specify the Ethernet port.
- For photo diode output monitor option add suffix -MD.
- For 2 ns rise time, specify the -TR option. The maximum amplitude is reduced by 10% when the -TR option is present.
- For the double pulse option, add the suffix -DP. This option causes the maximum amplitude to be reduced by 30%.
- The minimum PRF of the internal oscillator is 1 Hz on -B units.

AVO-9W-B MAINFRAME



The cables lead to the output module, not shown. (See below and next page for typical output modules.)

TYPICAL AVO-9B-C SYSTEM, FOR A 9 mm TO-18 LASER DIODE

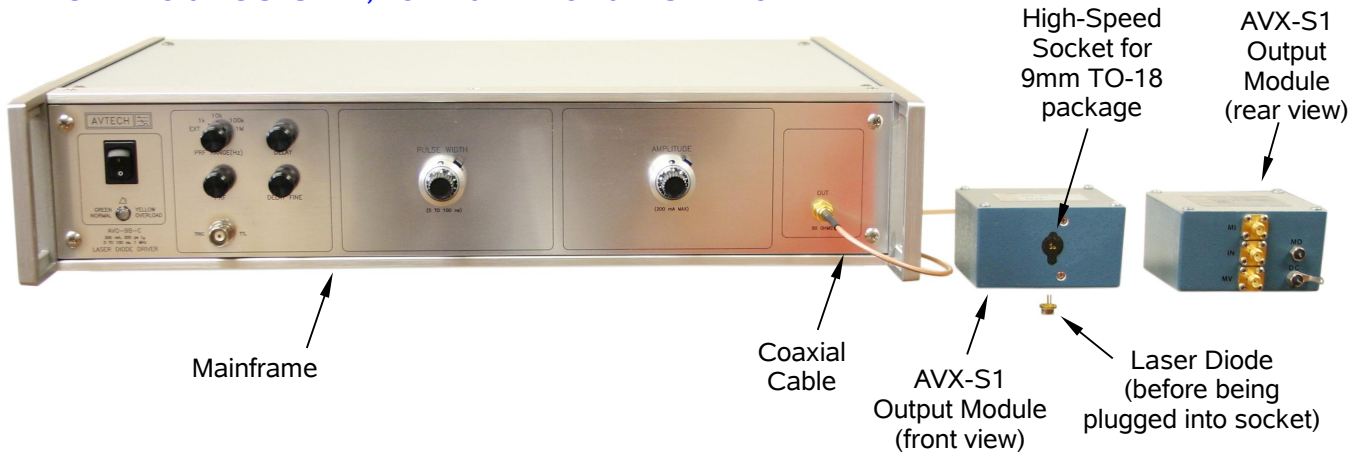

AVX-S1-P1B Functional Equivalent Circuit

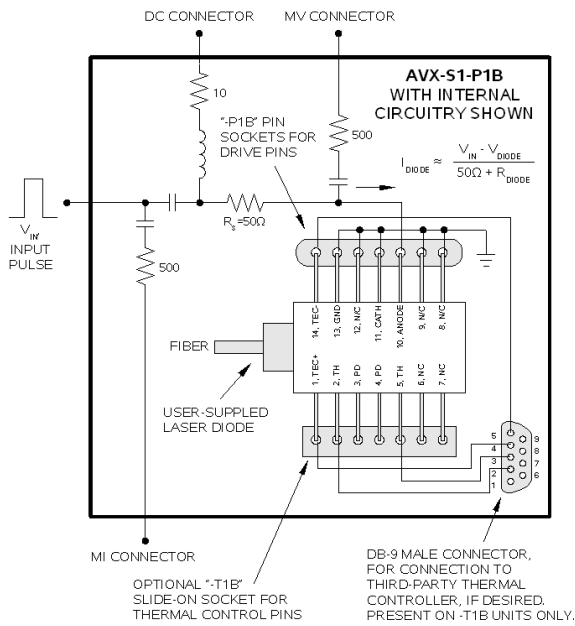

AVX-S1-HC-P1B Functional Equivalent Circuit

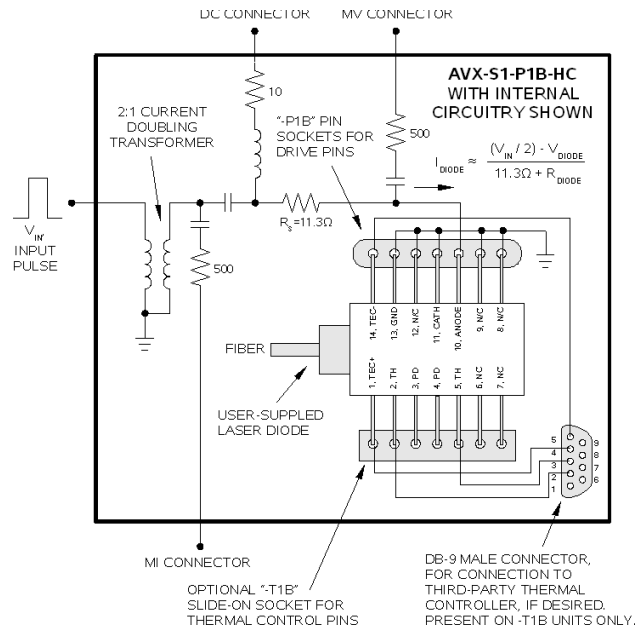

The exact pin configuration of the diode package must be specified at the time of ordering, so that a suitable socket can be provided. The above circuits illustrate one common configuration, which requires a positive pulser. See the AVX-S1 and AVX-S1-HC datasheets (<http://www.avtechpulse.com/laser-bias/avx-s1>) for more information and for examples of packages that can be accommodated.

OUTPUT MODULE FOR A BUTTERFLY-PACKAGED DIODE, WITHOUT THE -T1B OR -T1C OPTIONS

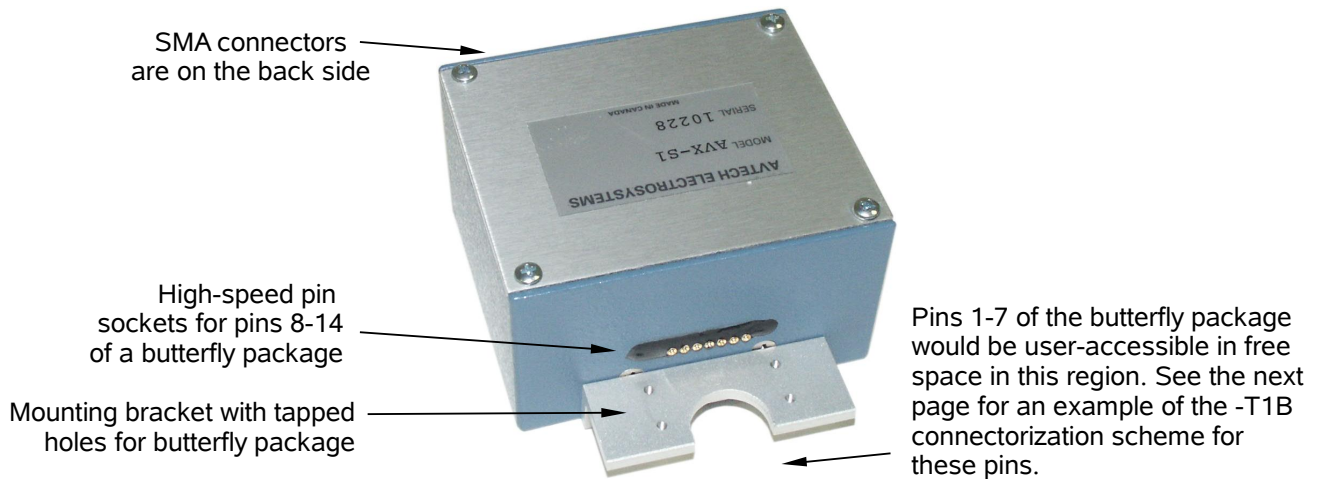

SAMPLE OUTPUT MODULE FOR A BUTTERFLY-PACKAGED DIODE, WITH THE -T1B OR -T1C OPTIONS

The photos below show the procedure from inserting a typical pigtailed device into an output module with the -P1B and -T1B options (or the -P1C and -T1C options). This is just an example; your diode may differ. (For instance, the fiber may exit the diode on the opposite side.)

Step 1 - Understand the Mechanical Aspects

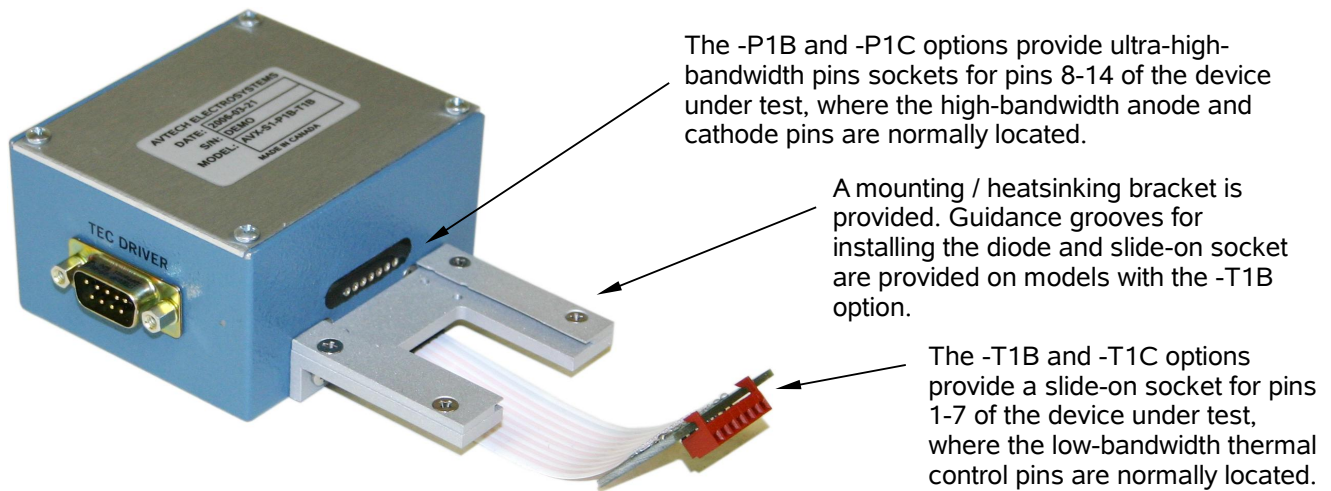

Step 2 - Insert the Diode into the High-Bandwidth Pin Sockets

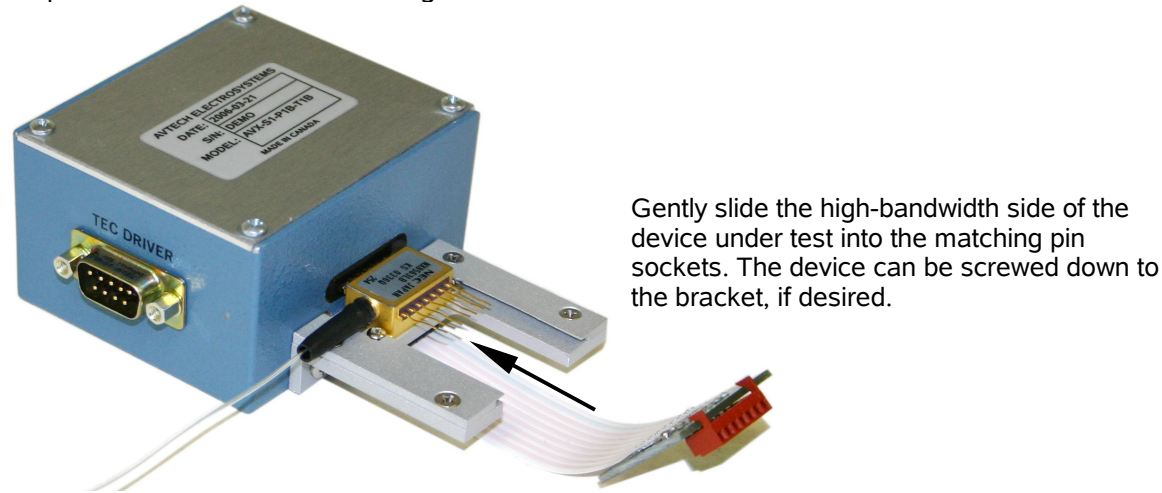

Step 3 - Install the Slide-On Socket on the Low-Bandwidth Pins

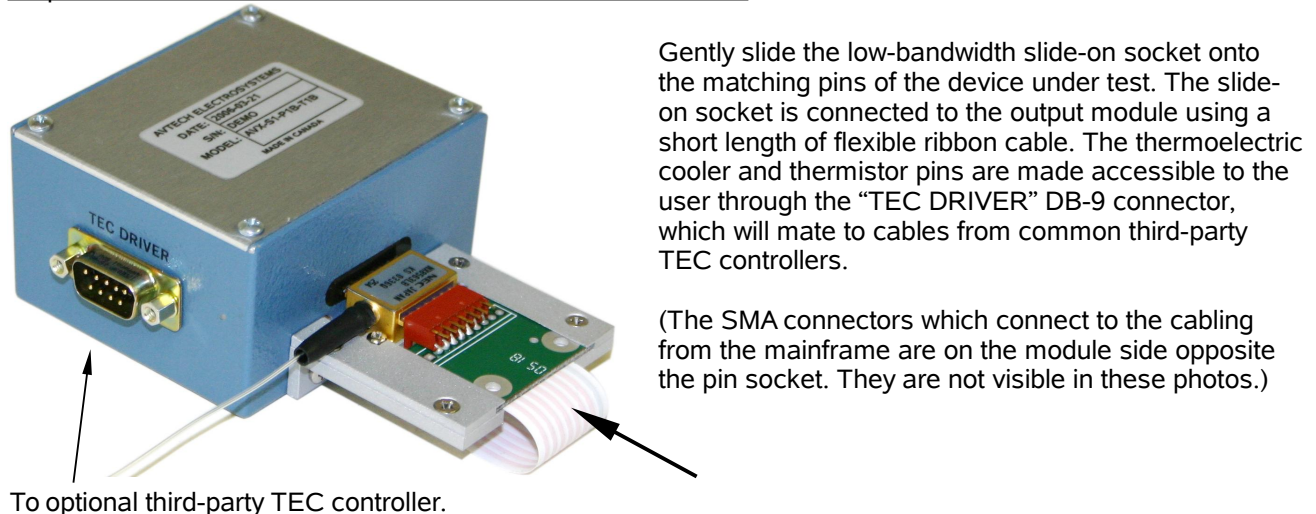

TYPICAL OUTPUT MODULE DIMENSIONS (APPROXIMATE)

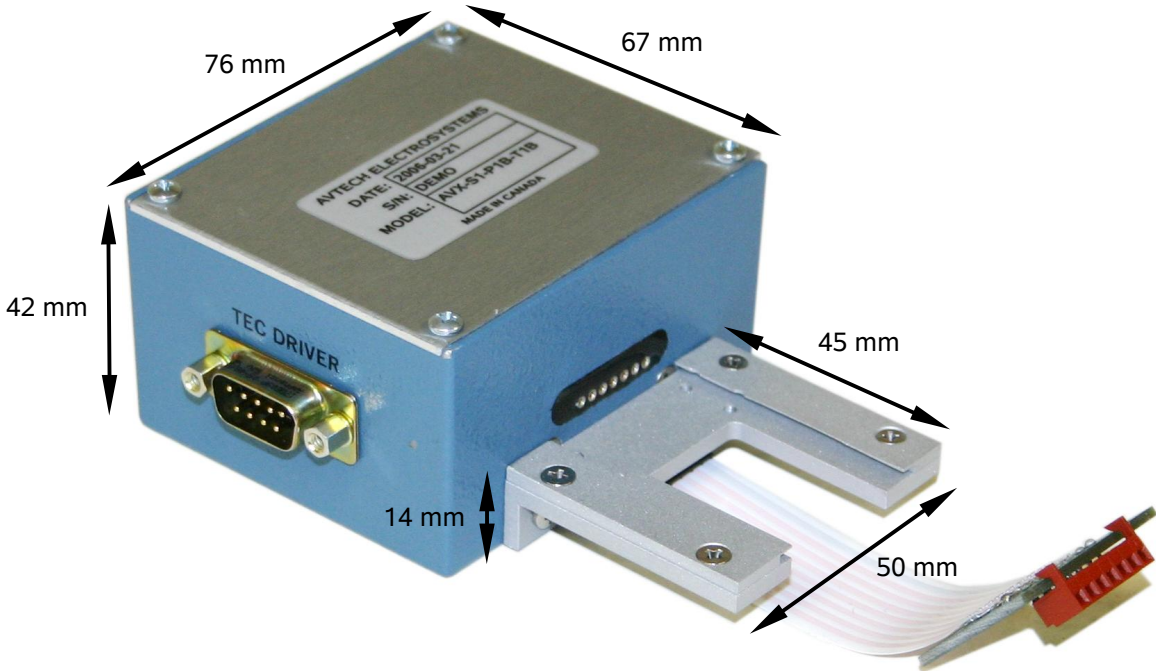

TYPICAL MOUNTING HOLE PATTERN (BOTTOM VIEW)

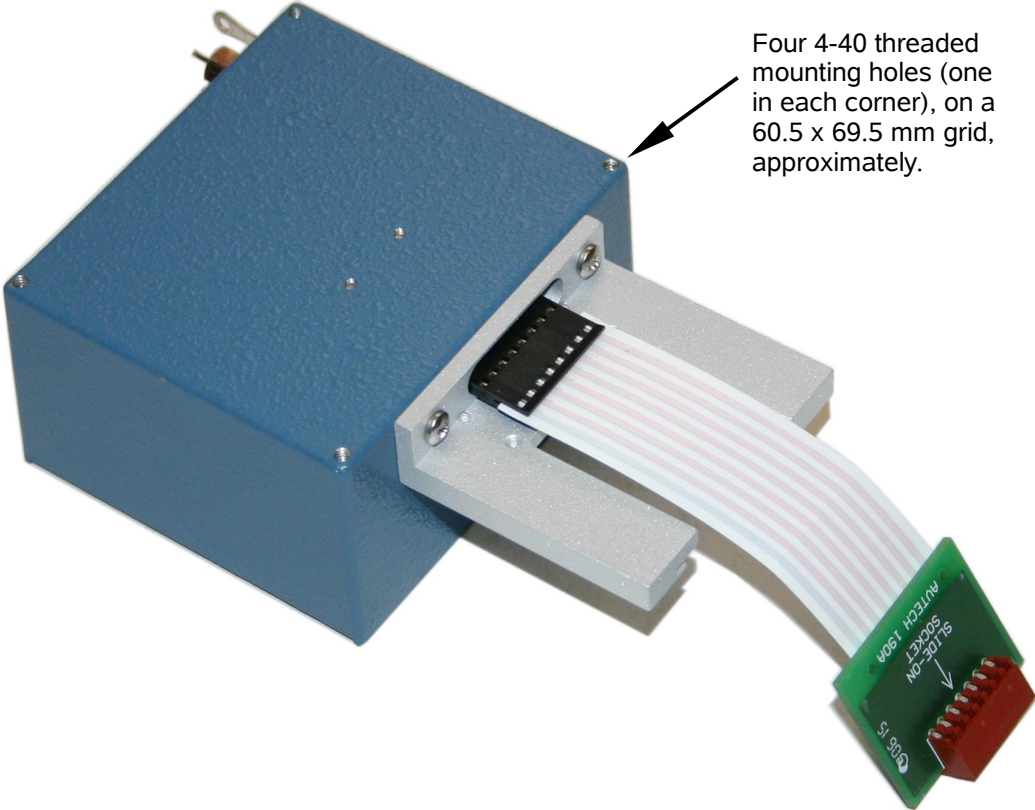

OEM-STYLE CUSTOMIZED MODULES

For some model families, Avtech can provide OEM-style brick-sized DC-powered externally-triggered modules, rather than benchtop-style instruments. Contact the factory (info@avtechpulse.com) with your special requirement.

A typical example of a customized module (designed to accept butterfly-style packages) is shown below:



The basic dimensions of the blue module shown in the photo (excluding the connectors and brackets) are 1.67" x 3" x 6", or 42.4 x 76.2 x 152.4 mm.

Avtech does not offer PCB-level products.