



OEM Seed Laser Diode Driver Assembly

- OUTPUT CURRENT UP TO 1.2 AMPS
- OUTPUT PULSEWIDTH 10ns TO CW
- FAST RISETIME OF 6ns
- COMPLIANCE VOLTAGE TO 3.0V
- +5VDC INPUT POWER
- RoHS COMPLIANT



DESCRIPTION:

AMI's Model 763 OEM seed laser diode driver is ideal for driving 14-pin butterfly packaged laser diode modules for use in CW or pulsed fiber MOPA systems. Applications include materials processing, LIDAR systems for remote sensing, fiber optic temperature sensing, laser communication and ranging. The driver is implemented as a transconductance amplifier (analog voltage in, scaled current out). The driver circuitry operates from a single 5V power source. All other needed voltages are generated on the board by high efficiency switching power supplies. The 763 is manufactured to the RoHS Directive 2002/95/EC requirements. All required mating cables are included.

SPECIFICATION:



PARAMETER	Min.	Typical	Max.	Units
INPUT				
Power	4.75	5.0	5.25	VDC
Current	-	0.330	3.5	A
Current Control (50 Ω Impedance, 0.333A/V Scaling)	0	-	4.5	V
OUTPUT				
Current	0.1	-	1.2	A
Bias Current (Trimpot adjustable)	0	-	90	mA
Compliance Voltage	-	2.0	3.0	V
Pulsewidth	10	-	CW*	ns
Repetition Rate	Single Shot	-	50*	MHz
Duty Cycle	0	-	100	%
Risetime (Optical) @ 1A	-	6	10	ns
Falltime (Optical) @ 1A	-	6	-	ns
TEC Current	0	1.80	3.0	A
TEC Voltage	0	3.14	4.2	V

* Limited by maximum output power.

Specifications are subject to change without notice.

APPLICATIONS:

Seed Laser Diode Driver/Pump Laser Diode Driver for Pumping Fiber Lasers, LIDAR, Communication

ABSOLUTE MAXIMUM RATINGS:

PARAMETER	Min.	Max.	Units
INPUT			
Power	-	5.5	VDC
OUTPUT			
Power (25°C, still air)	-	1.0	W
Power (25°C, ≥ 200LFM forced air)	-	1.25	W
TEMPERATURE			
Operating:	0	+50	°C
Storage:	-20	+70	
Humidity:		< 95% Non-Condensing	

PROTECTION:	Adjustable current limit
	Driver disabled when laser diode die temperature is outside of TEC set point by $\pm 1^\circ\text{C}$
	Driver disabled when the laser current driving FET's junction temperature exceeds 125°C
CONNECTIONS:	
Power:	2 pin Terminal Block (<i>Molex 39257-002</i>)
Interface:	8 Pin AMP MicroMatch Connectors (<i>7-215460-8</i>)
Current Control:	MMCX Micro Coax Connector
SIZE:	2.9" x 3.00" x 0.6"
THERMAL:	On-board TEC Controller will provide heating and cooling as necessary to maintain desired operating point. Thermistor and the TE cooler are in the laser diode package (not included). Customer may need to provide thermal mass and/or forced air for heatsinking under high dissipation conditions.

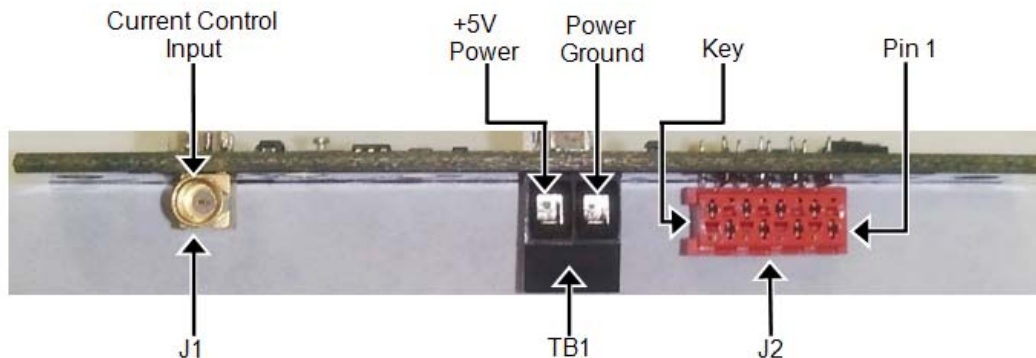

INPUT/OUTPUT and POWER CONNECTORS

I/O CONNECTOR Pinout	
J2	
Pin	Function
1	Enable
2	GND
3	Temp Fault
4	GND
5	Over Current
6	GND
7	Laser Fire
8	GND

J2 PIN DESCRIPTION

Laser Pinout	
Pin	Function
1	TEC +
2	Thermistor
3	BFM Anode
4	BFM Cathode
5	Thermistor
6	N/C
7	N/C
8	N/C
9	N/C
10	LD Anode
11	LD Cathode
12	N/C
13	Case Ground
14	TEC -

LASER DIODE 14-PIN BUTTERFLY PACKAGE PINOUT

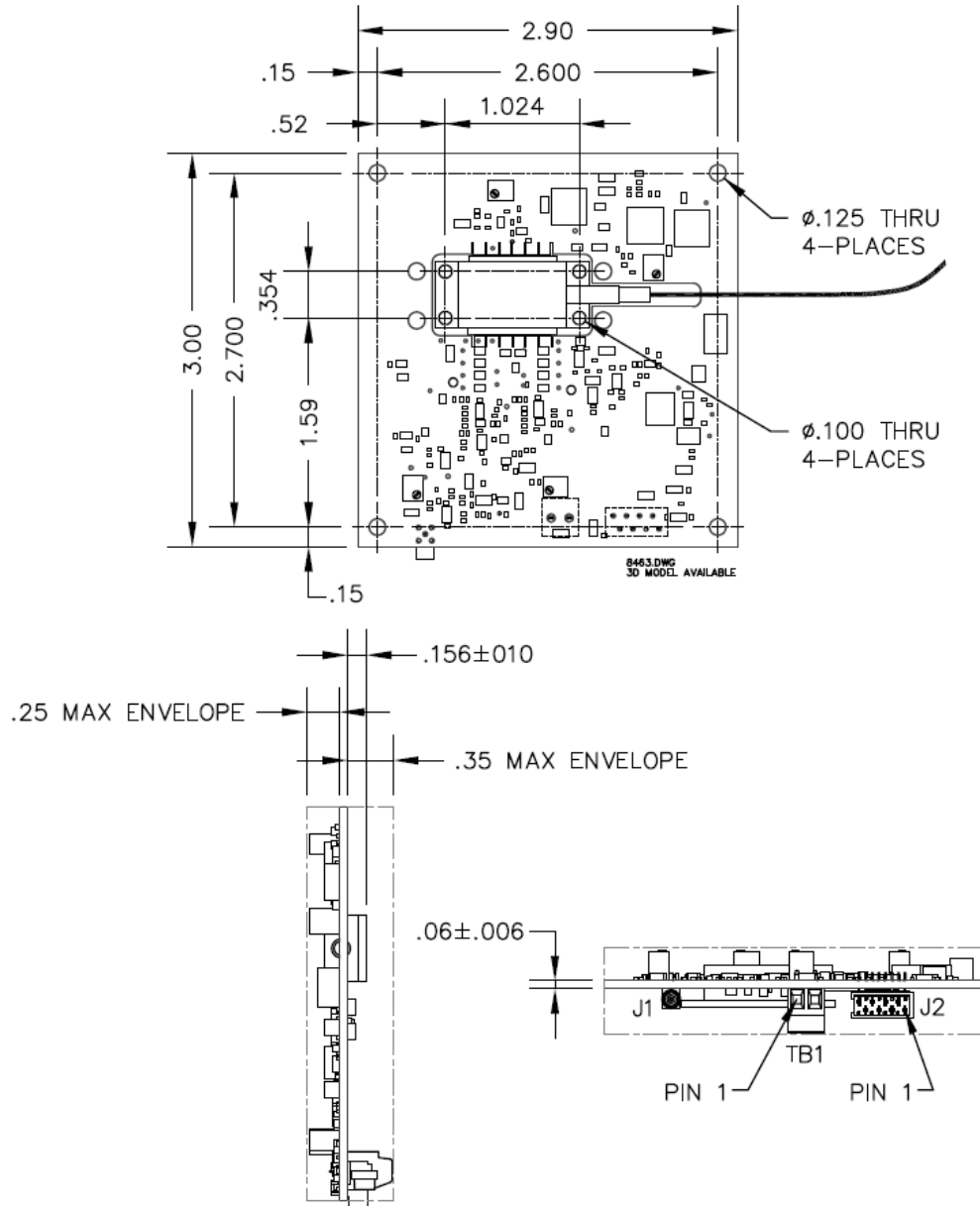

SAMPLE OPTICAL OUTPUT PULSE WAVEFORMS

Test Laser: Lumics P/N LU1064M400 400mW, 1064nm

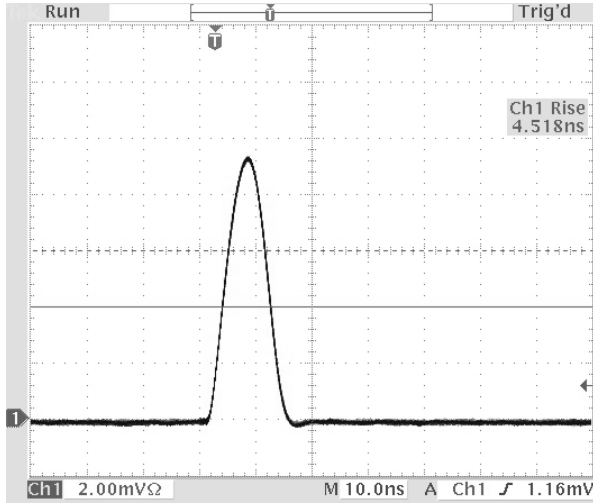

10ns Pulse Width, 500mA Drive Current

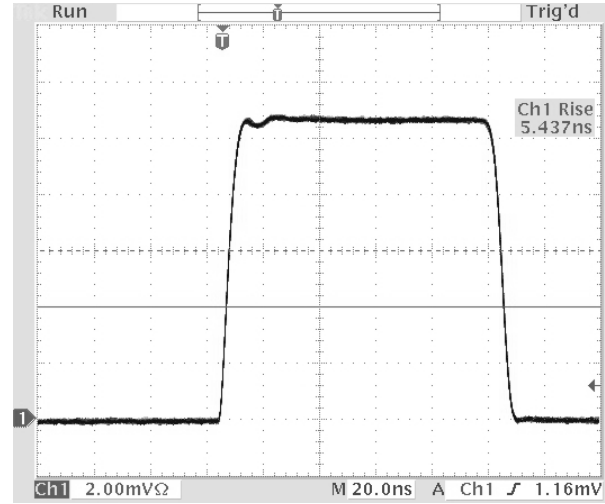

100ns Pulse Width, 500mA Drive Current

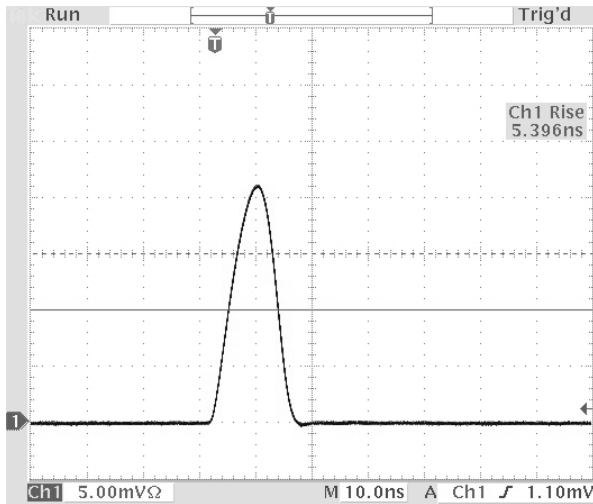

10ns Pulse Width, 1A Drive Current

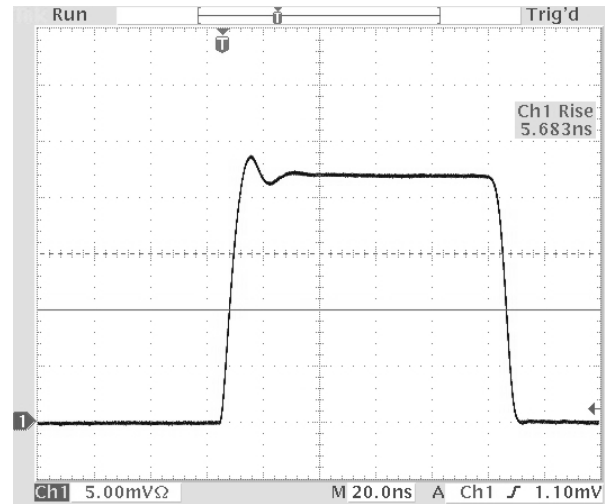

100ns Pulse Width, 1A Drive Current

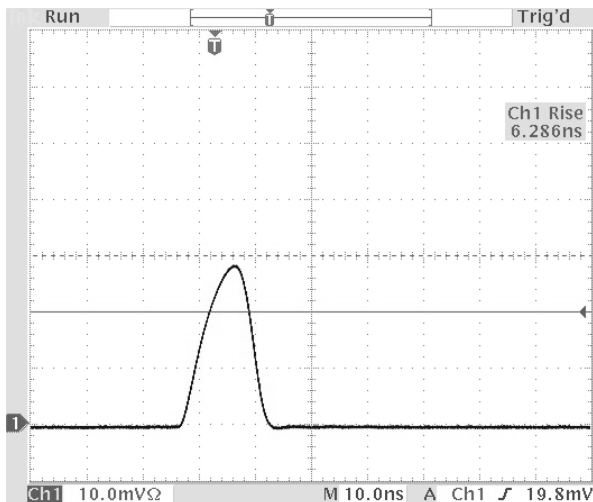

10ns Pulse Width, 1.2A Drive Current

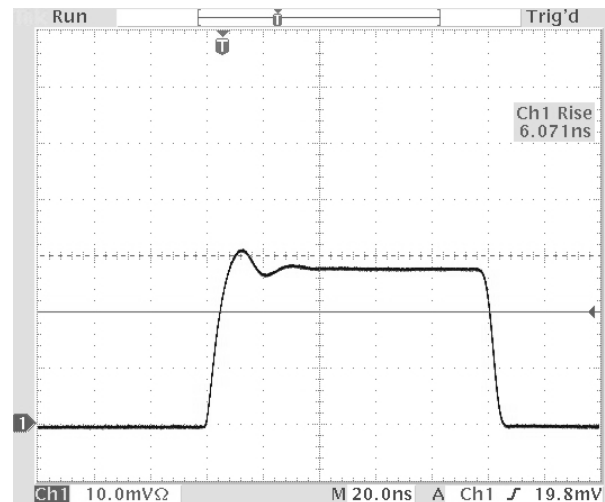

100ns Pulse Width, 1.2A Drive Current