



LASER LAB SOURCE

AeroDiODE
An ALPHANOV spin-off company

PRODUCT MANUAL

3SP-CCS-CW-HP

contact@LaserLabSource.com

800.887.5065

**Cool & Control
Series**

*CC-S CW Single-Mode laser
diode driver*



Contents

Revision Sheet.....	2
1. General information	3
1.1 Definitions	3
1.2 General warning.....	3
2. Safety Instructions.....	4
2.1. Wiring.....	4
2.2. Operating Environment.....	4
2.3. Contact	4
3. Package Content.....	5
4. Overview of the product.....	5
5. Laser diode Installation	6
6. Getting started	6
7. Setting the current limit	8
8. Operating modes.....	8
8.1. Current source	8
8.2. DC current.....	9
8.3. Temperature	9
8.4. Laser enable.....	9
9. Menu bar	9
10. Technical Specifications.....	10
10.1. General Data	10
10.2. Detailed data.....	10
11. Supported laser diodes.....	11
11.1. Type 1 Butterfly laser : standard CCS	11
11.2. Type 2 Butterfly laser : CCS-Type2 (“Type 2” sticker on top of the product).....	11



Revision Sheet

Release No.	Date	Author	Revision Description
V1.2	27/03/2020	AMU	First version under AERODIODE

Disclaimer

Information in this document is subject to change without notice.

Copyright © Aerodiode – Optical and Laser Technological Center
Bât. IOA, rue François Mitterrand - 33400 Talence – France
www.aerodiode.com
Fax: (408) 744-9049
www.aerodiode.com



1. General information

Please read this manual carefully, it describes the hazard the user might be exposed to while using the product. It also explains in details how to use the product in the safest and more efficient way possible.

The safety of any system incorporating the product is the responsibility of the assembler of the system.

Any actions taken by the user that is not clearly described in this user manual might present a risk and is the sole responsibility of said user.

This product is to be used in laboratory or industrial tasks, and only by personnel who have followed a training in laser hazard.

1.1 Definitions

Caution : A caution is advised when dealing with hazardous situations, tasks or objects, to prevent harm or death and avoid material damage or failure.

Warning : A warning is given for potentially dangerous situation for people which cause them harm or lead to death

Note : A note is a complementary piece of advice that must be acknowledged by the user.

1.2 General warning

Caution

The compatible laser diodes used with the CC-S can deliver up to several Watts of coherent LASER radiation. Always wear protective goggles and observe the safety instructions provided by the laser diode supplier when using the CC-S driver with your laser diode.

WARNING

Do not try to open or remove the cover of the CC-S module

Note

Only use the genuine power supply, and the supplied USB cable



WARNING

Avoid all chocs and strains when handling the CC-S

WARNING

Handle the fiber-optics cable with care as it is fragile. Do not bend or pinch it.

WARNING

Any software settings or hardware tinkering that is not described in this user manual or in the usage recommendation may put the user or its environment at risk.

WARNING

the maintenance and servicing of the CC-S should not be executed by the end user : only AERODIODE is able to maintain the CC-S.

2. Safety Instructions

2.1. Wiring

Caution

- Please first connect the input pins to the board and then plug the DC Power Supply.
- Use caution when connecting the Power Supply.
- Protect the power cord from being walked on or pinched particularly at plugs, convenience receptacles, and the point where they exit from the CC-S module.
- Connect the ground completely. Electric shock may occur if the ground is not connected correctly.

2.2. Operating Environment

Caution

- Do not install near any heat sources such as radiators, heat registers, stoves, or other equipment (including amplifiers) that produce heat.
- To reduce the risk of fire or electric shock, do not expose the CC-S to rain or moisture.

WARNING

Not following the safety recommendations and the caution mentioned above can lead to eye damage.

2.3. Contact

If you have any question about the CC-S module, please contact AERODIODE.



3. Package Content

The CC-S package comes with:

- 1 CC-S board
- 1 DC Power Supply (+12V DC / 4A)
- 1 USB-Jack FTDI cable
- 1 USB Key with “Aerodiode Control Software Suite” & User manual in pdf
- 1 User Manual

4. Overview of the product

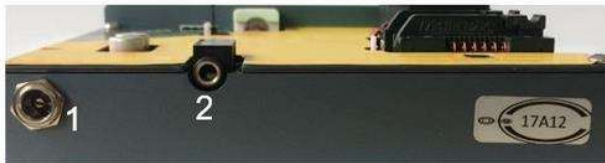

- 1- DC power input (+12 V / +24 V) DC power supply
- 2- USB input (input jack; USB-specific cable provided)



- 3- Temperature alarm indicator
- 4- Signal power adjustment (analog input 0-5V)
- 5- Signal power adjustment (manual knob)
- 6- Power ON indicator (Blue LED)



- 7- BFM connector (directly connected to laser diode integrated Back-Facet-Monitor photodiode).
- 8- Interlock Input
- 9- Alarm monitor (inverted TTL)



5. Laser diode Installation

The CC-S CW driver is dedicated to drive type 1 butterfly laser diodes (14 pins, see pin allocation below) with internal monitoring photodiode and thermoelectric cooler. The laser diode output fiber must go above the CC-S CW package.

Note

Use a torque screwdriver for the diode and please refer to the maximum allowed torque given in the diode specification (usually around 15 to 18cNm).

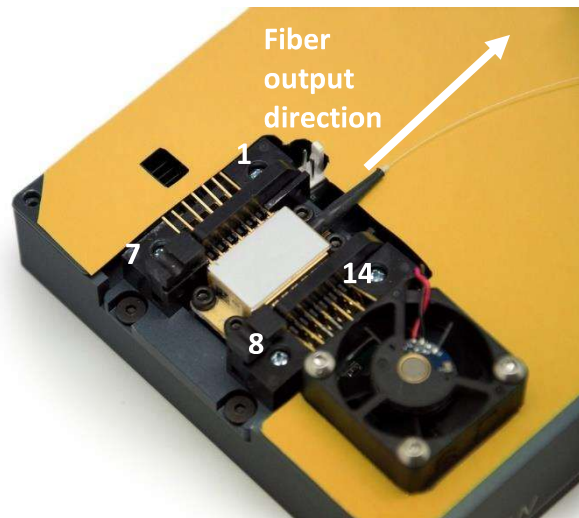

6. Getting started

The CC-S CW USB specific cable should be unplugged during the installation.

Double-click on setup.exe to run the installer. The control software will be installed, as well as the driver for the USB cable. A computer restart may be required to complete the installation.

- When the software is installed, plug the USB cable into a USB port of your computer.
- Next, plug the 3,5 mm jack into the USB input female jack of the CC-S CW.
- Plug-in the CC-S CW power supply to turn on the CC-S CW laser diode driver



Click on the item “ALPhANOV Control Software” located in the Start Menu to run the CC-S CW control software.

A window will appear:



Click on Connect to start the CC-S CW hardware detection. The software will automatically detect any USB-connected CC-S CW.

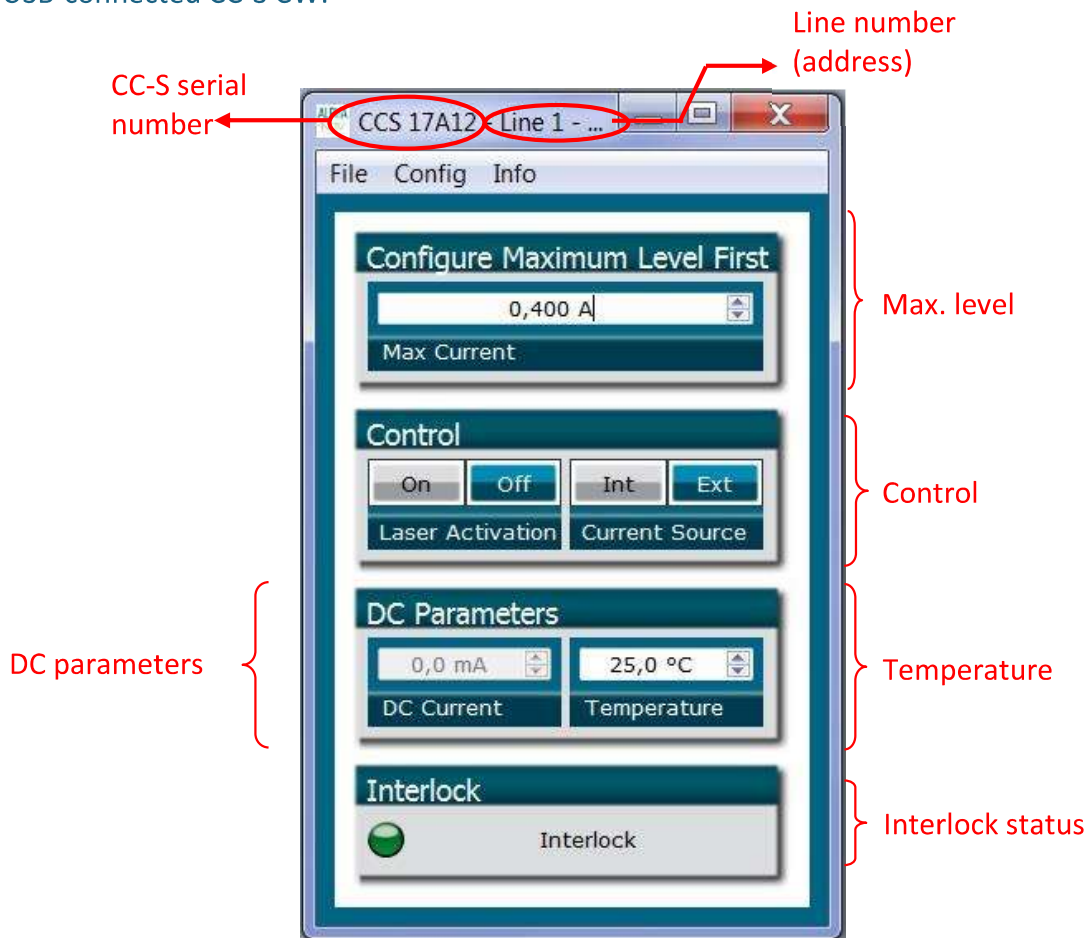

The window is divided in four parts:

- The maximum current is settable in the **Maximum level** part. This parameter must be correctly chosen in accordance to the laser diode specifications and maximum ratings.
- Triggers in the **Control** part are used to select the operating mode
- The **DC parameter** is used to configure the DC current (internal current source mode)
- The **Temperature** numeric box is used to set the laser diode temperature
- The **Interlock** status is ON (green) when the interlock jumper is plugged

The product serial number is written on the top left of the window. The line number (address) is on the top right.

7. Setting the current limit

The CC-S CW laser diode driver includes a hardware overcurrent protection which requires to be set up before driving the laser diode.

Before plugging your laser diode into the CC-S CW socket, please configure this value to the maximum value recommended by the laser diode supplier. **By default, this value is set to zero so the driver will not supply current.** You have to change this value for enabling the driver output.

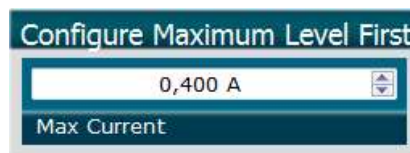

8. Operating modes

8.1. Current source

This two positions switch controls the current source.



External source
(BNC or manual knob)





Internal source (software)

8.2. DC current

This item rules the continuous current flowing through the laser diode.



DC current
This item sets the DC current amplitude

8.3. Temperature

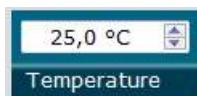

This item configures the internal temperature of the laser diode (on the range 10°C / 50°C)

8.4. Laser enable



Enables/Disables the laser emission

9. Menu bar

- File
 - Load parameters
Click on this item to load a .csv file which contains the operating parameters.
 - Save parameters
Click on this item to save the current parameters into a .csv file. This file can be loaded using the “Load parameters” menu item.
 - Exit
Close the window. A confirmation is asked before shutting down the software: the laser state can be either active or inactive after the software is stopped.
- Config > General Config



Restricted access to internal configuration parameters. Please use only this when asked by ALPhANOV.

- Config > Save

Click on this menu item to save the current operating parameters into the CC-S CW internal memory. These parameters will be saved as default parameters in the flash memory and will be retrieved by the driver at the next power on (even if the CC-S CW driver is not connected to the PC).

Please note that if the laser state is active and parameters saved into memory, the lasing will be effective after a shutdown.



- Info > General information

Displays information about the current version and the internal parameters.

10. Technical Specifications

10.1. General Data

Length	130	mm
Width (edge to edge)	110	mm
Width (Connector to connector)	125	mm
Height (top plate)	18	mm
Height with fins	28	mm
Weight	400	g
Power connector (Jack, positive tip)		mm
Power supply (DC)	12V / 4A	
Safety Features	Interlock	
	Over Temperature Protection	
	Laser Current Limit	

10.2. Detailed data

CCS / SOA	Min	Max	Resolution	Impedance	Bandwidth
Operating temperature	-15°C	+40°C			
Storage temperature	-25°C	+70°C			
Operating Altitude	–	2000m			
Output current for CW mode	0 A	800 mA	12 bits		
Laser Diode Temperature	15°C	50°C	0,1°C		
Sync Out	LVTTTL			50 Ohm	250 MHz
BNC peak power adjustment	0 V	5 V		47 KOhm	15 Hz
Alarms	0 V (active)	5 V (Not active)		1 KOhm	



APENDIX

11. Supported laser diodes

11.1. Type 1 Butterfly laser : standard CCS

Standard CCS are well adapted for Type 1 Butterfly laser diodes :

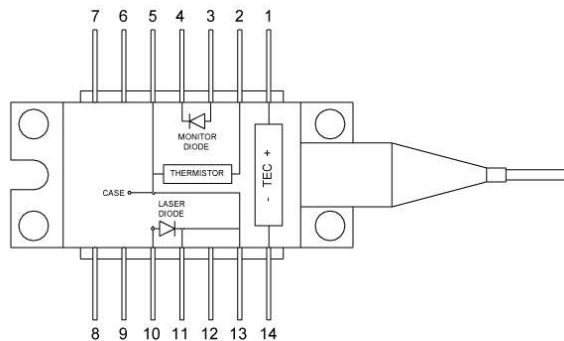

11.2. Type 2 Butterfly laser : CCS-Type2 (“Type 2” sticker on top of the product)

Type-2 and Type-2 Bias-T laser diode are compatible with the CCS – Type 2. Standard two pinouts of type-2 with floating anode are shown below.

Type 2 laser diodes require the CCS “Type-2” version :

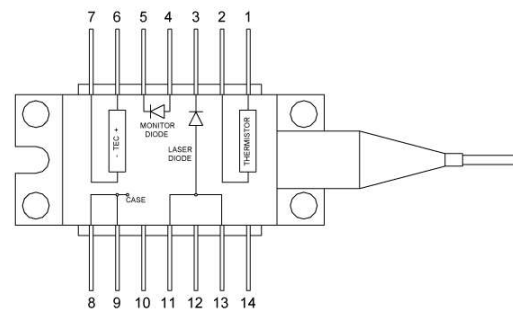

Type 2 with Bias-T laser diodes require the CCS “Type-2” version :



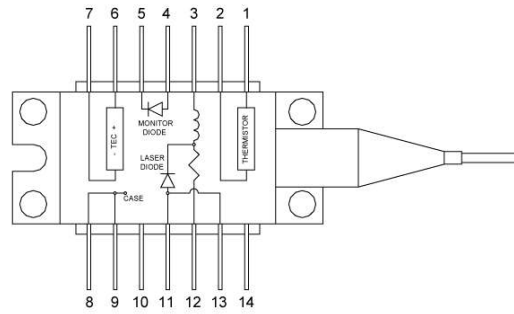

If the anode of type-2 laser (pin 11 or/and 13) is connected to the case (ground) (pin 8 or/and 9) the type-2 diode is called “anode grounded”. As the product is intended for use with positive driven current, the current will go directly to the ground without going through the cathode of the laser diode. In this case, the user should mechanically isolated the laser diode by using furnished resin screws (M2,5 screws) and a thermal pad (electrical insulator) between the diode case and the base plate.

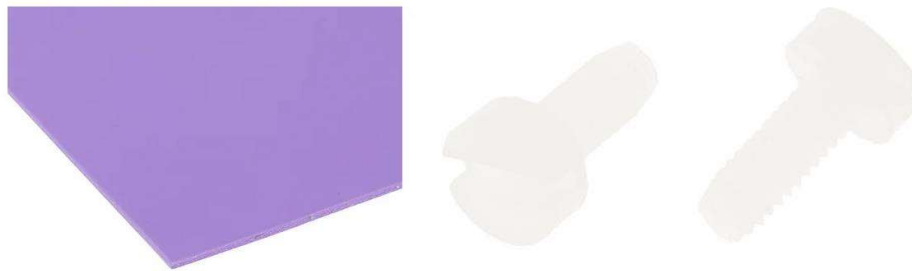

Figure 1 : Silicone thermal pad and resin screws

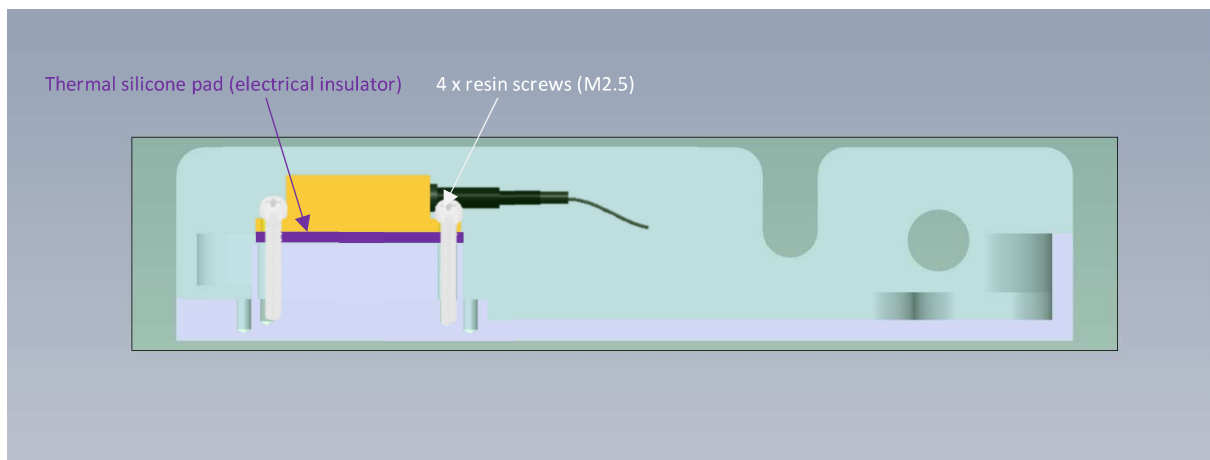

Figure 2 : Cross-section view for mounting type-2 anode grounded laser diodes