

LASER DIODE CONTROL ELECTRONICS AND MOUNTING MODULE – SF8150-ZIF10

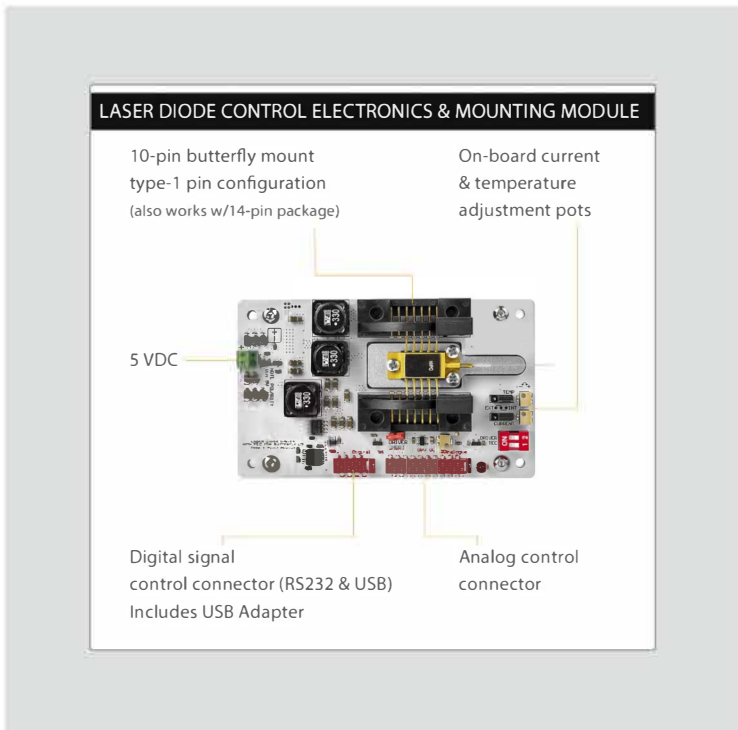

Operating Manual

Semiconductor Laser Sources and Control Instruments

Table of content

1. Laser diode driver features 3

2. Applications 3

3. TEC controller features 3

4. Controls..... 3

5. Description..... 3

6. Package set 3

7. Overall dimensions and weight 3

8. Versions 4

9. Absolute maximum ratings..... 5

10. Recommended operating conditions 5

11. Power supply requirements 6

12. Electrical characteristics 6

13. Typical Performance Characteristics 7

14. Functional scheme 9

15. Pin and terminal functions 10

16. Analog control description 13

17. Current / Temperature setting variants 14

18. How to get started 15

19. PID coefficients 16

20. Cooling 17

21. Internal protections 17

22. Software..... 18

23. Digital control description 18

24. Digital control description (extended)..... 24

25. Troubleshooting guide..... 27

26. Mechanical dimensions 28

27. Warranty..... 30

1. Laser diode driver features

- Constant current mode
- Low current ripple $\leq 10\mu\text{A}$
- Current stability 0.1%
- No need to adjust voltage
- Soft-start
- Adjustable current limit
- Reverse current protection
- Crowbar circuit protection
- Own software

2. Applications

- Supplying laser diodes in butterfly case

5. Description

The SF8xxx contains a laser diode driver and a temperature controller (TEC).

The laser diode driver is a non isolated low drop out (LDO) regulator with constant current output. The driver produces high stability and low ripple current.

The TEC is a non isolated DC/DC. TEC produces low current ripples. Additional features include an adjustable TEC output current limit and full PID controller with the ability to set all the coefficients, providing optimal temperature regulation.

The SF8xxx can be controlled by analog or digital signals and switches on the board.

The SF8xxx is housed in 61 × 101.6 mm package with aluminum base plate to aid thermal dissipation from the laser diode. The laser diode mount is located on the board. Driver can be mounted on any thermal conductive surface enough to dissipate laser diode losses.

6. Package set

- Driver – 1 pcs
- 50 cm ribbon cable with one 8-pin connector – 1 pcs
- 50 cm ribbon cable with one 20-pin connector – 1 pcs
- Datasheet & User Manual – 1 pcs
- USB-UART converter – 1 pcs (for ZIF versions)
- High thermal conductivity graphite sheet – 1 pcs (for ZIF versions)

7. Overall dimensions and weight

LD mount and case	Overall dimensions, mm	Weight, g (average, +/- 3g)
10-pin for soldering	61 x 101.6 x 18.6	117
10-pin with Azimuth connectors	61 x 101.6 x 28.3	141
14-pin for soldering	61 x 101.6 x 20.1	132
14-pin with Azimuth connectors	61 x 101.6 x 28.3	138

¹ Option, USB as external adapter

3. TEC controller features

- Low current ripple $\leq 2\text{mA}$
- Full PID controller with the ability to set all the coefficients
- Adjustable TEC output current limit
- Working with sensor NTC 10kOhm
- Additional NTC thermistor input

4. Controls

- Potentiometers on the board
- External input
- Digital control by RS-232/UART/USB¹

8. Versions - Type 1 Pinout (see Pg 12)

Device	LDD MAX current, mA	LD mount	LD case
SF8025-10	250	Soldering	10-pin Type 1
SF8025-ZIF10	250	Plug-in connector	10-pin Type 1
SF8025-14	250	Soldering	14-pin Type 1
SF8025-ZIF14	250	Plug-in connector	14-pin Type 1
SF8075-10	750	Soldering	10-pin Type 1
SF8075-ZIF10	750	Plug-in connector	10-pin Type 1
SF8075-14	750	Soldering	14-pin Type 1
SF8075-ZIF14	750	Plug-in connector	14-pin Type 1
SF8150-10	1500	Soldering	10-pin Type 1
SF8150-ZIF10	1500	Plug-in connector	10-pin Type 1
SF8150-14	1500	Soldering	14-pin Type 1
SF8150-ZIF14	1500	Plug-in connector	14-pin Type 1
SF8300-10	3000	Soldering	10-pin Type 1
SF8300-ZIF10	3000	Plug-in connector	10-pin Type 1
SF8300-14	3000	Soldering	14-pin Type 1
SF8300-ZIF14	3000	Plug-in connector	14-pin Type 1

Versions - Type 2 Pinout (see Pg 12)

Device	LDD MAX current, mA	LD mount	LD case
SF8025-14-T2	250	Soldering	14-pin Type 2
SF8025-ZIF14-T2	250	Plug-in connector	14-pin Type 2
SF8075-14-T2	750	Soldering	14-pin Type 2
SF8075-ZIF14-T2	750	Plug-in connector	14-pin Type 2
SF8150-14-T2	1500	Soldering	14-pin Type 2
SF8150-ZIF14-T2	1500	Plug-in connector	14-pin Type 2
SF8300-14-T2	3000	Soldering	14-pin Type 2
SF8300-ZIF14-T2	3000	Plug-in connector	14-pin Type 2

	MIN	MAX	UNIT
Vin+ to Vin-	-0.3	5.5	V
Operating temperature	-40	50	°C
Analog control pins to GND	-0.3	5.5	V
RS-232 RXD to GND	-25	25	V
RS-232 TXD to GND	-13.2	13.2	V
UART RXD to GND	-0.3	5.5	V
UART TXD to GND	-0.3	5.5	V

Stresses beyond those listed under absolute maximum ratings may cause permanent damage to the device. These are stress ratings only, which do not imply functional operation of the device at these or any other conditions beyond those indicated under recommended operating conditions. Exposure to absolute-maximum-rated conditions for extended periods may affect device reliability.

10. Recommended operating conditions

	MIN	MAX	UNIT
Input voltage (V_{in})	4.8	5.2	V
Operating temperature	-10	40	°C
analog control pins to GND	0	5	V
RS-232 RXD to GND	-12	12	V
RS-232 TXD to GND	-12	12	V
UART RXD to GND	0	5	V
UART TXD to GND	0	5	V

11. Power supply requirements

The driver requires a 5V DC power supply. The power supply must be able to cover the driver and TEC output power and losses. The power supply must provide 20W or more (depending on the driver version) and line regulation $\pm 1\%$. Recommended power supply: Mean Well RS-35-5.

12. Electrical characteristics

PARAMETER	TEST CONDITIONS	MIN	TYP	MAX	UNIT
OUTPUT LDD					
Output voltage		0.5		3	V
Output current	SF8025	0		250	mA
	SF8075	0		750	
	SF8150	0		1500	
	SF8300	0		3000	
Current ripple			10	15	uA
Pulse rate	Set by RS-232 or UART	0.1		100	Hz
Pulse duration	Set by RS-232 or UART	1		5000	ms
Rise time (Soft-start time)	SF8025	400	600	700	us
	SF8075	600	800	1100	
	SF8150	800	1000	1200	
	SF8300	1000	1200	1400	
Fall-time (Stop time)	SF8025	1300	1700	1800	us
	SF8075	700	800	1400	
	SF8150	400	500	600	
	SF8300	300	300	400	
Error-triggered fall-time (Stop time)	SF8025	8	15	25	us
	SF8075	8	15	25	
	SF8150	8	15	25	
	SF8300	8	15	25	
OUTPUT TEC					
Output voltage		0		± 4	V
Output current		0		± 4	A
Current ripple			2	4	mA
Temperature change range		+15		+40	$^{\circ}$ C
CONTROLS					
Enable pins low threshold				1	V
Enable pins high threshold		2.3			V
Interlock pin threshold				1	V
Interlock pin pull-up resistance			10		k Ω
LDD current set pin voltage vs. output current	SF8025		100		mA/V
	SF8075		300		
	SF8150		600		
	SF8300		1200		
LDD current set step	Set by RS-232 or UART		0.5		mA
LDD current set accuracy			1		%

LDD current set calibration		-5		+5	%
TEC temperature set step	Set by RS-232 or UART		0.01		°C
TEC temperature set accuracy			1		%
TEC temperature set calibration		-5		+5	%
AUX SUPPLY					
2.5V accuracy			0.2		%
2.5V output current				10	mA
INTERNAL MEASUREMENTS					
Internal measurements accuracy			2		%
LDD current monitor pin voltage vs. output current	SF8025		100		mA/V
	SF8075		300		
	SF8150		600		
	SF8300		1200		
External sensor temperature	NTC 10k	-10		150	°C
INPUT					
Vin quiescent current		7	10	20	mA
Operating current				7	A

13. Typical Performance Characteristics

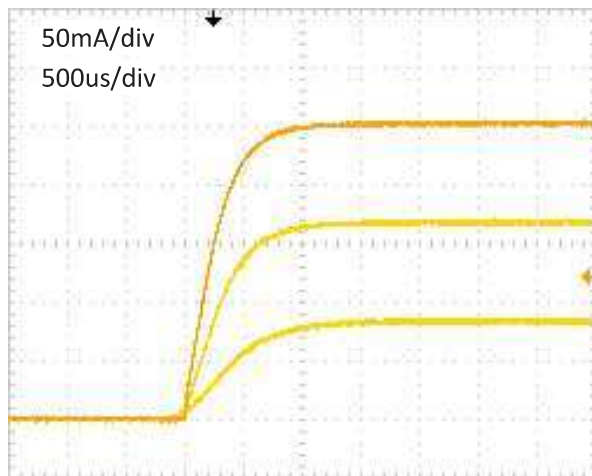

Fig. 1 – Typical start up sequence SF8025

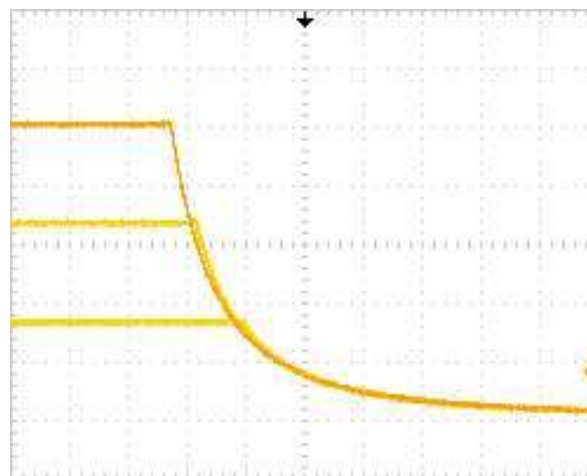

Fig. 2 – Typical stop sequence SF8025

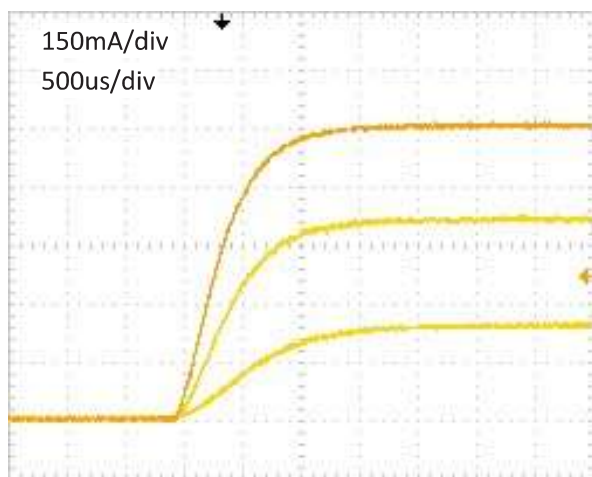

Fig. 3 – Typical start up sequence SF8075

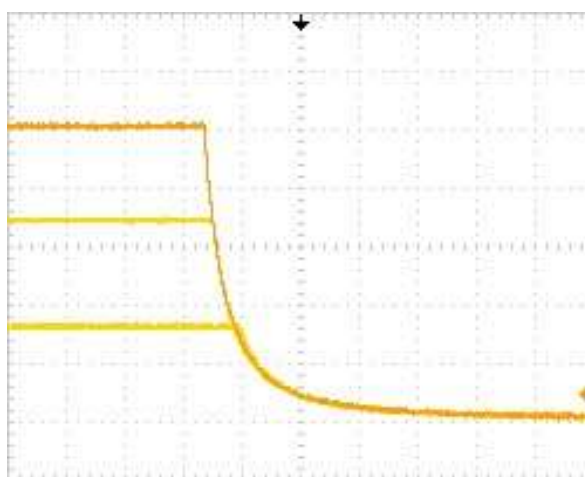

Fig. 4 – Typical stop sequence SF8075

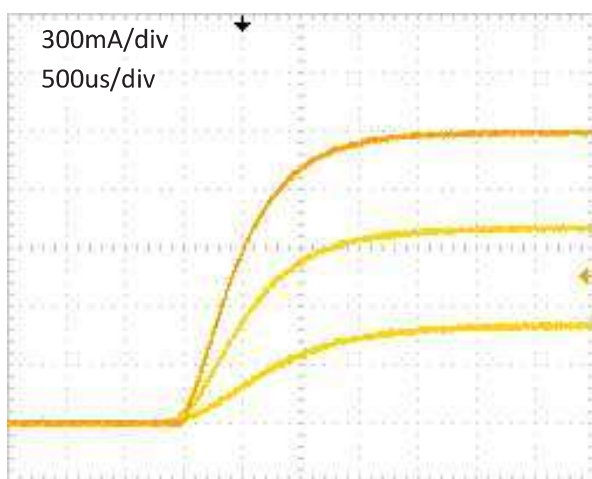

Fig. 5 – Typical start up sequence SF8150

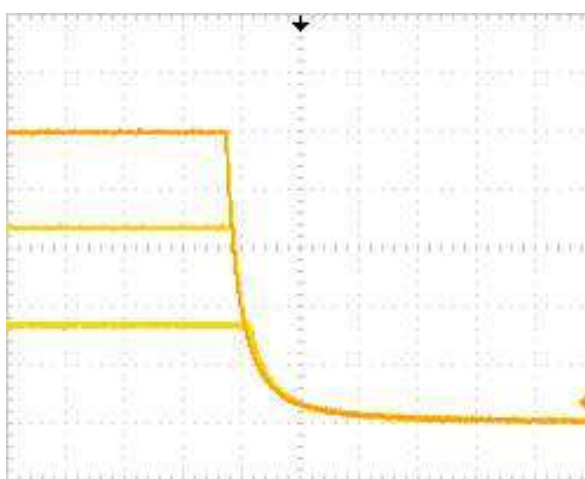

Fig. 6 – Typical stop sequence SF8150

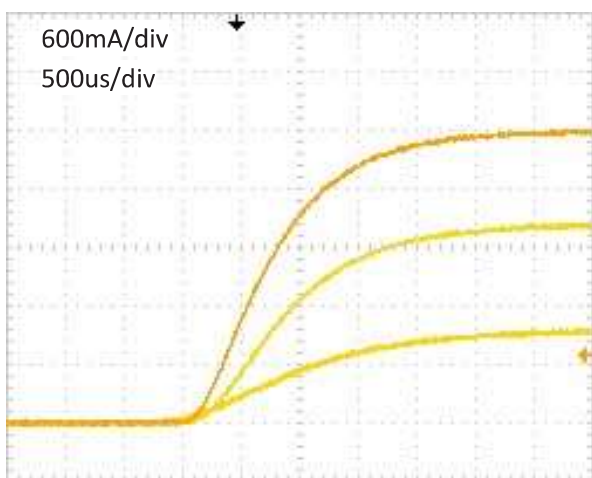

Fig. 7 – Typical start up sequence SF8300

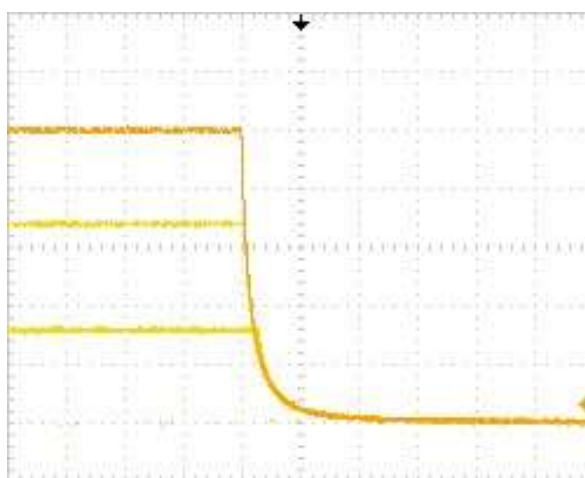
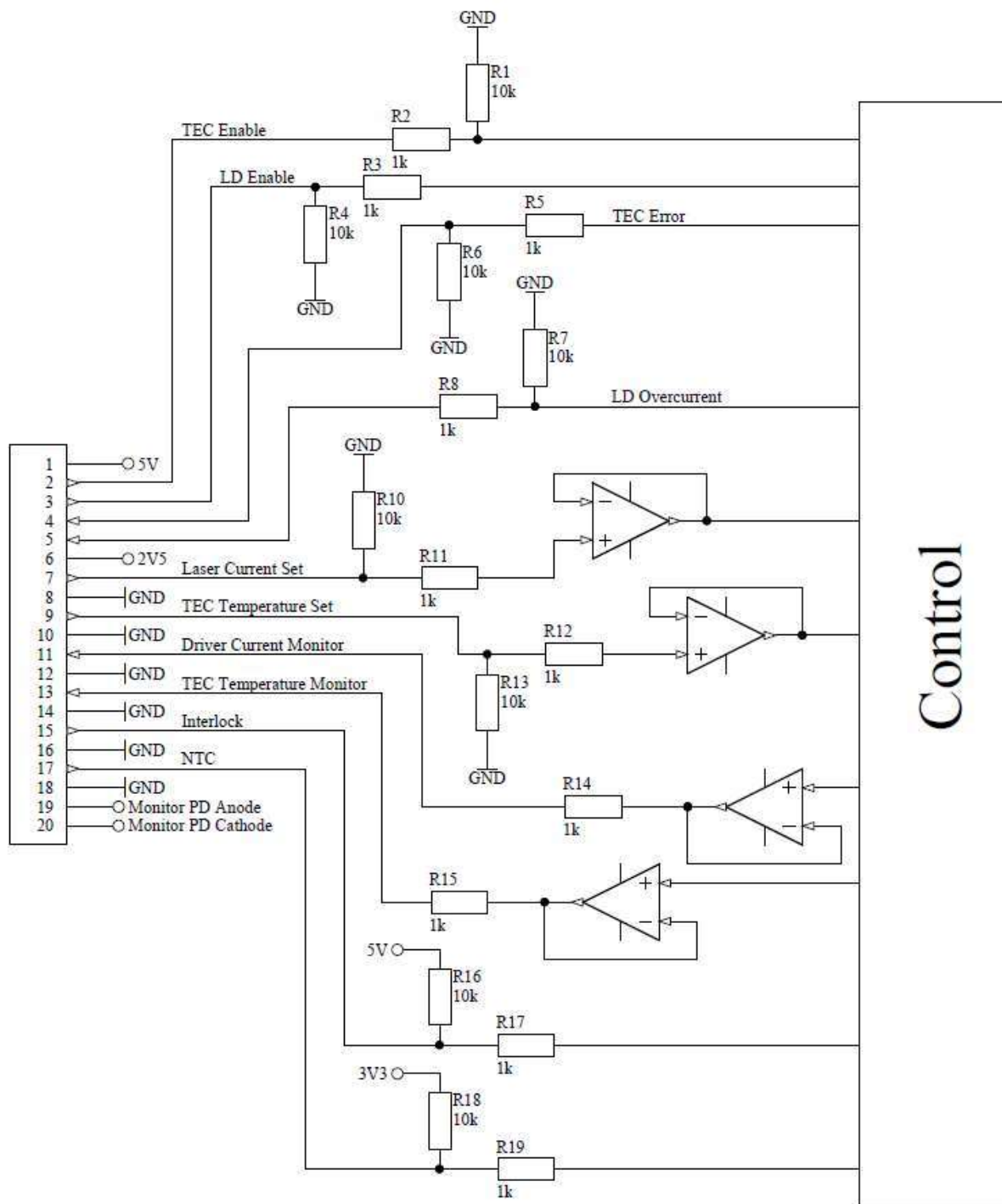

Fig. 8 – Typical stop sequence SF8300

14. Functional scheme

Analog interface



15. Pin and terminal functions

Please note input and output polarity.

Never ground any lead of the output; permanent damage to the laser diode and driver may result. Never use any grounded probes (e.g. from the oscilloscope) at the output: the control pins are not isolated.

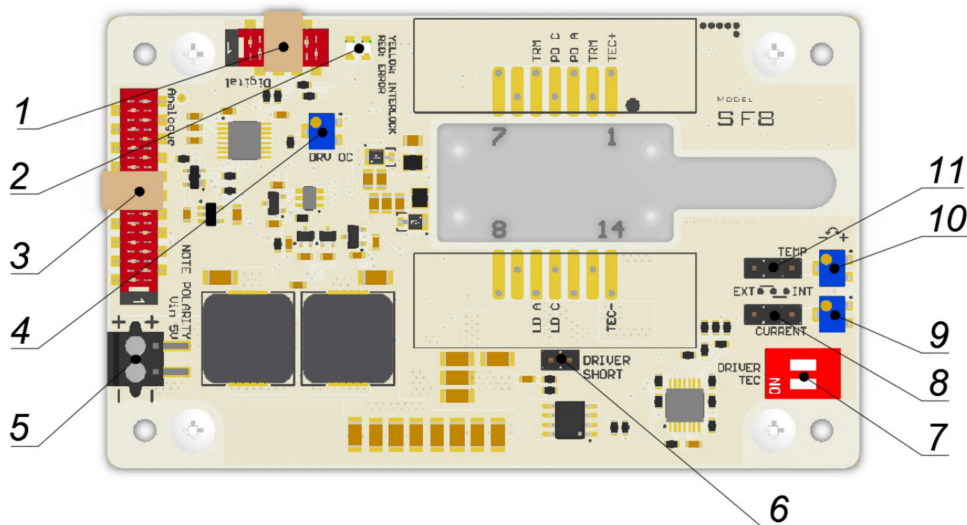

Fig. 9 – Controls

No	Description
1	Digital control connector
2	Laser diode driver overcurrent protection (red) and interlock (yellow) indicators. Lights red when the protection is activated. To reset, the device must be restarted. Lights yellow when the driver is in the locked state (see paragraph 18.1).
3	Analog control connector
4	Current limit adjustment potentiometer. Turning the potentiometer clockwise increases the value, counterclockwise - reduces. Adjustment from zero to maximum occurs in 12 turns.
5	Terminal for connecting the power supply 5V. Maximum wire cross-section 0.75 mm ² . NOTE POLARITY
6	ESD protection LD short. Remove when the laser module is set up!
7	Two-position switch. One switch enables temperature controller (TEC), another switch enables laser diode driver (DRIVER). Switches are duplicated on the analog control connector.
8	Current control selector. Close 1-2 to use analog control connector (EXT), 2-3 to use potentiometer (INT).
9	Output current of laser diode driver adjustment potentiometer. Turning the potentiometer clockwise increases the value, counterclockwise - reduces. Adjustment from zero to maximum occurs in 12 turns.
10	TEC temperature adjustment potentiometer. Turning the potentiometer clockwise increases the value, counterclockwise - reduces.
11	The temperature control selector. Close 1-2 to use analog control connector (EXT), 2-3 to use potentiometer (INT).

Digital control connector

Würth WR-MM 690157000872 or TE Connectivity 215083-8

Pin	Description
1	UART RXD
2	RS-232 RXD
3	UART TXD
4	RS-232 TXD
5	Connected to Vin+
6	Interlock (duplicates pin 15 of analog control connector)
7	Crowbar status (duplicates pin 5 of analog control connector)
8	GND (connected to Vin- terminal)

analog control connector

Würth WR-MM 6901 5700 20 72 or TE Connectivity 2-215083-0

PIN	I/O	Name	Description
1	O	+5V	Connected to Vin+.
2	I	TEC Enable	HIGH = operates, LOW = stop. Internally pulled down.
3	I	Laser Driver Enable	HIGH = operates, LOW = stop. Internally pulled down.
4	O	TEC Error	HIGH = fault, LOW = normal operation.
5	O	Laser Driver Overcurrent	HIGH = fault, LOW = normal operation.
6	O	+2.5V	Auxiliary +2.5V power supply. Up to 10mA output current capability.
7	I	Laser Current Set	0-2.5V = 0-MAX current at the output.
8		GND	
9	I	TEC temperature set	0V = 42°C, 2.5V = 16°C.
10		GND	
11	O	Driver Current Monitor	0-2.5V = 0-MAX current at the output.
12		GND	
13	O	TEC temperature monitor	0V = 42°C, 2.5V = 16°C.
14		GND	
15	I	Interlock	Open = locked; Low = operates. Internally pulled up.
16		GND	
17		NTC Interlock	Connect NTC thermistor 10k between this pin and GND.
18		GND	
19		Monitor PD Cathode	Connected to pin 4 of Butterfly.
20		Monitor PD Anode	Connected to pin 3 of Butterfly.

Laser diode pinout - Type 1 Pinout (ie. Pump Lasers)

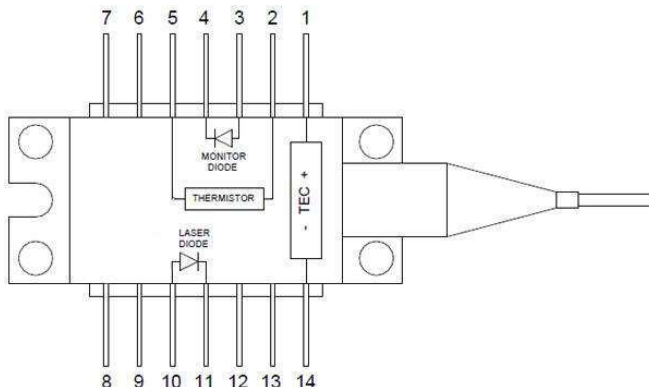

No	Description	No	Description
1	TEC Anode	14	TEC Cathode
2	Thermistor	13	n/c
3	Monitor PD Anode	12	n/c
4	Monitor PD Cathode	11	LD Cathode
5	Thermistor	10	LD Anode
6	n/c	9	n/c
7	n/c	8	n/c

Laser diode pinout - Type 2 (ie. Telecom Lasers)

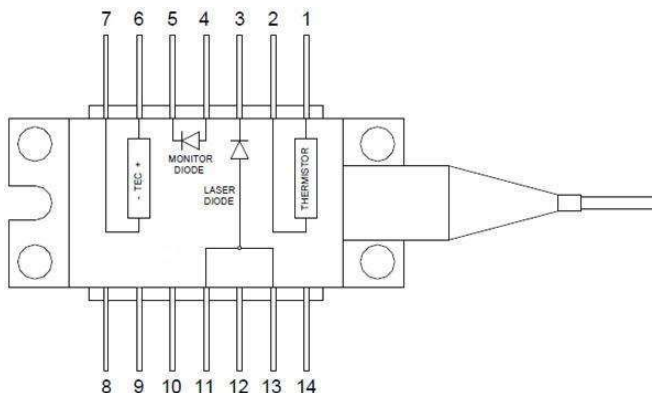

No	Description	No	Description
1	Thermistor	14	n/c
2	Thermistor	13	LD anode (+)
3	LD cathode (-)	12	n/c
4	PD anode (+)	11	LD anode (+)
5	PD cathode (-)	10	n/c
6	TEC anode (+)	9	n/c
7	TEC cathode (-)	8	n/c

16. Analog control description

16.1. Laser Driver Enable / TEC Enable

The "Enable" contacts are logic inputs.

Apply high level to «*TEC Enable*» pin to start temperature stabilization. Apply low level to «*TEC Enable*» pin to stop temperature stabilization.

Apply high level to «*Laser Driver Enable*» pin to initiate soft-start sequence of laser diode driver. Apply low level to «*Laser Driver Enable*» pin to stop the driver.

The enable features are duplicated with on-off switches located on the board (7 in Fig. 9).

16.2. TEC Error

The «*TEC Error*» contact is logic output.

TEC error signal generates in overcurrent, short-circuit or circuitry overheat condition.

If an error occurs «*TEC Error*» pin becomes high.

A TEC error stops the laser driver. To reset the error, restart the device.

16.3. Laser Driver Overcurrent

The «*Laser Driver Overcurrent*» contact is logic output.

The «*Laser Driver Overcurrent*» pin is intended for monitoring the status of the protection circuits. When the current protection is activated, the laser driver stops, the output terminals are shunted, the LED on the board lights up red. The high logic level in the contact indicates the presence of shunting of the output terminals. The current generator cannot be restarted after the protection has tripped. To reset the protection, restart the driver.

16.4. Reference voltage 2.5V

The «*+2.5V*» pin is intended for supplying a reference voltage to external potentiometers etc., which may be used for current and temperature setting.

16.5. Laser Current Set

The «*Laser Current Set*» pin is an analog input.

The «*Laser Current Set*» is intended for setting the driver output current amplitude. Apply voltage to the «*Laser Current Set*» with respect to GND to control the output current. Signal resolution depends on driver model, maximum amplitude of the signal is 2.5V.

The «*Laser Current Set*» pin can be used for analog modulation by applying sign, square or ramp signal with the DC component. Please, control the output current while using this feature. In this case, the value of the DC component determines the average current in the load, and the amplitude of the signal determines the modulation amplitude. It is necessary to ensure that the current for analog modulation does not exceed the current protection threshold. analog modulation amplitude depends on frequency.

ATTENTION! If you use arbitrary/function generator or lab PS for current set, make sure it is in High Z mode. Use caution when using this mode, and use a diode dummy load to configure the system prior to connecting the laser diode.

When using a generator with a 50Ω output, the value on the screen of the device can be less than the actually set by 2x. Monitor the voltage on the contact «*Laser Current Set*» with an oscilloscope.

16.6. TEC temperature set

The «*TEC temperature set*» pin is an analog input.

The «*TEC temperature set*» is intended for setting the desired temperature of laser module. Apply voltage to the «*TEC temperature set*» with respect to GND to set the desired temperature.

The applied voltage must correspond to the desired resistance of the thermistor.

The specified voltage U [V] is related to the resistance of the thermistor R [Ohm] by the formula:

$$U = \frac{2.5 R}{10000} - 1.25$$

For example, to obtain a thermistor resistance of 10000 Ohm, a voltage of 1.25 V must be applied to the «*TEC temperature set*» pin. The 10 kOhm resistance corresponds to 25 ° C for the NTC thermistor 10k. A lower input voltage corresponds to a lower resistance of the thermistor (higher temperature) and vice versa.

When translating the resistance of the thermistor to the temperature t [° C], it is necessary to consider the coefficient $B_{25/100}$ [K], specified in the manufacturer's specifications:

$$t = \frac{1}{\frac{\ln \frac{R}{10000}}{B_{25/100}} + \frac{1}{298.15}} - 273.15$$

16.7. Driver current monitor

The output current of the driver can be monitored by current monitor.

16.8. TEC temperature monitor

The «*TEC temperature monitor*» pin is an analog output and allows to track the temperature of the laser diode.

Proportions described in paragraph 16.6 are valid for this Pin.

16.9. NTC Interlock (External thermistor connection)

This allows temperature measurement of a laser diode or other devices. The measurement result is readable by the digital interface. You can set upper and lower limits of the temperature using the digital interface (with command or software). If the temperature goes beyond the limits, the driver operation is blocked. When the temperature returns to the specified range, the driver operation resumes. After setting, limits will be saved in device memory and will work when used both digital and analog control.

17. Current / Temperature setting variants

Parameters can be set in three ways: using potentiometer, analog control connector or digital commands. Signal sources for current and temperature can be set independently of each other.

Signal source	Digital state	Board jumper state
Potentiometer	External (default at power up)	INT
Analog control connector	External (default at power up)	EXT
Digital	Internal	INT or EXT

18. How to get started

Unpack the device. The new device is configured with the following values:

Parameter	Value
Peltier module current limit (set by digital)	2A
Temperature control (switch TEMP)	INT
TEC temperature set (potentiometer TEMP)	10kOhm (25°C)
Laser diode driver current set (potentiometer CURRENT)	0mA
Laser diode driver current control (switch CURRENT)	INT
Laser diode driver current protection threshold (potentiometer DRV OC)	2/5 of max current

For the first time we recommended to connect a dummy load. You can use any diodes that are suitable for the current you want to operate. Dummy load should be connected as load. LD+ to the anode and LD- to the cathode.

Do not turn on TEC if you have not connected a dummy load to the TEC pins.

Connect the controls (analog and/or digital).

Connect the power supply (note polarity).

18.1. Interlock

The driver has interlock. This is pin 15 of the analog control connector. If you left this pin open the driver is in the locked state. This pin must be connected to any GND pin for normal operation.

The driver and the temperature controller can only be turned on with shorted Interlock.

You can also connect a safety interlock switch to this pin.

By default at power up the driver is in the "allow interlock" state. Via USB you can set the driver to the "deny interlock" state. At this case the driver will ignore interlock state and can operate with opened pin 15.

18.2. NTC Interlock

The driver can only be turned on with installed thermistor. When driver is turned on without the thermistor, the operation and measure values will be incorrect. If it is necessary to turn on the driver without the thermistor, connect a 10kΩ resistor to thermistor pins (2nd and 5th) on LD mount.

18.3. Change the current limit on the Peltier module

If it is necessary, the level of current limit on the Peltier module can be changed before connecting the laser diode using digital control connection (see paragraph 20).

18.4. Change the current protection threshold of the driver

The current protection threshold level sets with DRV OC potentiometer. The set level can be seen in the software or requested by a digital command. Set the current protection threshold to the required level before turn on the laser diode current.

If it is necessary, the current protection threshold can be changed using analog controls. Make sure that the jumper DRIVER SHORT is installed. CURRENT control selector must be in the INT position to use the CURRENT potentiometer.

Connect the measuring instrument to the «Driver Current Monitor» pin.

If it is necessary to increase the limitation level, turn the potentiometer DRV OC clockwise for a few turns.

Turn on the driver. Set the current equal to the desired current protection threshold with the potentiometer CURRENT. Then slowly turn the potentiometer DRV OC counterclockwise until the protection is activated. Restart the driver to reset an error. Make sure that the protection is triggered at the correct current level.

You can also set the current level by analog or digital signals.

Set current to zero, turn off the driver.

18.5. How to control by digital signals

Use the digital control connector. You can use UART or RS-232. The USB-UART converter can be used (optional) to connect the device to computer.

See paragraphs 22-23.

18.6. How to control by analog signals

CURRENT and TEC control selectors must be in the EXT position.

Use the analog control connector.

If you connect pins 2 and 3 to pin 1 (5V) before power up the device, the driver will not turn on.

See paragraph 16.

18.7. How to control by board switches

CURRENT and TEC control selectors must be in the INT position.

Use two-position switch to start/stop laser diode driver or temperature stabilization. If you set onboard switch to ON before power up the device, the driver will not turn on.

Turn CURRENT potentiometer (9 in Fig. 9) clockwise to increases the value of driver output current amplitude, counterclockwise – to reduce.

Turn TEC potentiometer (10 in Fig. 9) clockwise to increases the desired temperature of laser module, counterclockwise – to reduce.

19. PID coefficients

The device allows you to set P, I, and D coefficients independently of each other. The coefficients can be set in software or using digital commands.

The PID regulator works regardless of the control mode, both in analog and digital modes.

The default values are shown in the table. In most cases, default configuration will work well with butterfly laser diodes.

There may be instability in the operation of the thermal controller on some DFB diodes. In this case, set the configuration for DFB diodes.

Setup	P coefficient	I coefficient	D coefficient
Default	100	1000	0
DFB laser	20	1000	1000

Proportional coefficient sets direct response to the error signal. The value 100 is equal to a multiplier of 1, the value of 20 is equal to a multiplier of 0.2.

Larger proportional gain results in larger changes in response to the error, and thus affects the speed at which the controller can respond to changes in the system. While a high proportional gain can cause a circuit to respond swiftly, too high a value can cause oscillations. Too low a value and the circuit cannot respond quickly enough to changes in the system.

Integral control helps compensate for steady-state error, and prevents temperature offset.

Low values of the integral regulator lead to quick compensation, but can cause oscillations. Too large values lead to slow compensation. Zero value disables the integral regulator.

Derivative control attempts to reduce the overshoot and ringing potential from proportional and integral control. Derivative control slows the response of the circuit. High gain values cause the circuit to respond very slowly and can leave one susceptible to noise and high frequency oscillation. Zero value disables the derivative regulator.

Before fine-tuning the controller learn the theoretical foundations of PID controllers.

20. Cooling

The board does not require active cooling. Aluminum mount is designed to remove heat from the laser diode, but the aluminum baseplate must be mounted to a heat sink.

21. Internal protections

The device provides several security features to ensure the safety of the laser module.

The jumper shunts the outputs of driver, to protect the laser diode from static discharges while installing.

Before installing the laser module on the board, make sure the jumper is installed.

Remove the jumper before turning on the driver.

An internal everse diode protects the laser diode from reverse current and reverse voltage.

In case of an over-current or an over temperature condition, the control logic disables the driver and the output shorts with 2 mOhm shunt. Setting the current protection threshold is described in paragraph 18. The current protection threshold must be less than the laser module absolute maximum ratings.

The TEC current limit allows setting the maximum current safe for the Peltier module.

22. Software

We offer own software to control driver. Contact us via email or on our web page at www.LaserDiodeControl.com.

23. Digital control description

When the input voltage applied the driver is always in "analog parameters set, external enable and allowing interlock" state. Any other state should be set any time after powering the driver if needed.

Default serial port settings:

Baud rate	Data bits	Stop bits	Parity	Flow control
115200	8	1	none	none

Data exchange between the driver and the PC is only initiated by the PC. **All commands are sent in plain text format. All commands in text-plain mode should be in ASCII.** All commands are sent with prefix. Number of command follows the prefix without any symbols. If there is the value after the command they separates with "space" symbol. The command ends with "carriage return" symbol.

The format of the command to set the value (P-type):

Number of byte	Value	Comment
1	P (50h)	Set prefix
2-5	Number of the parameter	Hex-number of the parameter. For example, 0100h
6	'space' symbol (20h)	
7-10	New value of the parameter	Hex-value of the parameter. For example, 0000h
11	'return carriage' symbol<CR> (0Dh)	End of the command

The device does not respond to P-type commands by default (see section "the protocol extension").

You can request the value of parameter by the J-type command. The device will return a value of requested parameter.

The format of the command to get the value (J-type):

Number of byte	Value	Comment
1	J (4Ah)	Request prefix
2-5	Number of the parameter	Hex-number of the parameter. For example, 0100h
6	'return carriage' symbol<CR> (0Dh)	End of the command

The format of the response:

Number of byte	Value	Comment
1	K (4Bh)	Response prefix
2-5	Number of the parameter	Hex-number of the requested parameter
6	'space' symbol (20h)	
7-10	Returned value of the parameter	Hex-value of the parameter
11	'return carriage' symbol<CR> (0Dh)	End of the command

If the device could not recognize a command, it returns an error message with error code.

The format and codes of errors

Error (returned command)	Reasons (one or few)
E0000	1) Internal buffer of device is overflowed. 2) Cannot find <CR> (0x0D) or & and <LF> (0x0A). 3) Format of command is invalid.
E0001	1) Unknown command (it does not P- or J-type command). 2) The device failed to correctly interpret a command.
E0002	The CRC of received command (see section "Digital control description (extended)").
K0000 0000	Request or set the parameter that does not exist.

Available parameters and its description

Action		R/W	HEX-number of parameters
Frequency (0.1 Hz)	Value	R/W	0100
	Minimum	R	0101
	Maximum	R	0102
Duration (0.1 ms)	Value	R/W	0200
	Minimum	R	0201
	Maximum	R	0202
Current (0.1 mA)	Value	R/W	0300
	Minimum	R	0301
	Maximum	R/W	0302
	Maximum limit	R	0306
	Measured value	R	0307
	Current protection threshold	R	0308

Current set calibration (0.01%)²	Value		R/W	030E
Voltage (0.1 V)	Measured value		R	0407
State of the driver	Start (Enable)	0008h	W	0700
	Stop (Disable)	0010h		
	Internal current set	0020h		
	External current set	0040h		
	External Enable	0200h		
	Internal Enable	0400h		
	Allow Interlock ³	1000h		
	Deny Interlock ³	2000h		
	Deny ext. NTC Interlock ³	4000h		
Allow ext. NTC Interlock ³	8000h			
State of the driver (bit mask)	0 bit	1 – Device is powered on (always = 1)	R	0700
	1 st bit	0 – Stopped; 1 – Started		
	2 nd bit	Current set: 0 – External; 1 – Internal		
	4 th bit	Enable: 0 – External; 1 – Internal		
	6 th bit	External NTC Interlock: 0 – Allowed; 1 – Denied		
	7 th bit	Interlock: 0 – Allowed; 1 – Denied		
Serial number	Return the hex-value of the serial number		R	0701
Lock status (bit mask)⁴	1 st bit	Interlock	R	0800
	3 rd bit	LD over current		
	4 th bit	LD overheat		
	5 th bit	External NTC Interlock		
	6 th bit	TEC error		
	7 th bit	TEC self-heat		
Save parameters				0900
Reset parameters				0901

² Default – 100.00% (2710h), calibration range is from 95.00% (251Ch) to 105.00% (2904h).

³ Common for driver and TEC.

⁴ If temperature of the device reaches the over temperature warning threshold the overheat flag will be set. If the device is in over temperature protection state, then it will be set overheat and over current flags together.

External NTC sensor temperature (0.1°C)	Lower limit		R/W	0A05
	Upper limit		R/W	0A06
	Measured value		R	0AE4
	B _{25/100} (1 = 1 K)		R/W	0B0E
TEC temperature (0.01°C)	Value		R/W	0A10
	Maximum		R/W	0A11
	Minimum		R/W	0A12
	Maximum limit		R	0A13
	Minimum limit		R	0A14
	Measured value		R	0A15
TEC current (0.1 A)	Measured value		R	0A16
	Limit		R/W	0A17
TEC voltage (0.1 V)	Measured value		R	0A18
State of the TEC	Start (Enable)	0008h	W	0A1A
	Stop (Disable)	0010h		
	Internal temperature set	0020h		
	External temperature set	0040h		
	External Enable	0200h		
	Internal Enable	0400h		
State of the TEC (bit mask)	1 st bit	0 – Stopped; 1 – Started	R	0A1A
	2 nd bit	Temperature set: 0 – External; 1 – Internal		
	4 th bit	Enable: 0 – External; 1 – Internal		
Current set calibration (0.01%)⁵	Value		R/W	0A1E
Internal LD NTC sensor	B _{25/100} (1 = 1 K)		R/W	0A1F
P coefficient	Value		R/W	0A21
I coefficient	Value		R/W	0A22
D coefficient	Value		R/W	0A23

⁵ Default – 100.00% (2710h), calibration range is from 95.00% (251Ch) to 105.00% (2904h).

Examples

1) For the current value parameter, 0300:

To request value, send the following command:

"J0300" in text or "4a 30 33 30 30 0d" in hex.

Answer will be:

"4b 30 33 30 30 20 30 42 42 38 0d" in hex, "K0300 0BB8" in text, 0BB8h > 3000 in dec > 300.0 mA.

To set new value, 400 mA (0FA0 in hex) for example, send the following command:

"P0300 0FA0" in text or "50 30 33 30 30 20 30 46 41 30 0d" in hex.

2) For the TEC temperature value parameter, 0A10:

To request value, send the following command:

"J0A10" in text or "4a 30 41 31 30 0d" in hex.

Answer will be:

"4b 30 41 31 30 20 30 39 43 34 0d" in hex, "K0A10 09C4" in text, 09C4h > 2500 in dec > 25.00°C.

To set new value, 24.00°C (0960 in hex) for example, send the following command:

"P0A10 0960" in text, "50 30 41 31 30 20 30 39 36 30 0d" in hex.

3) For the state of the driver, 0700:

To request value, send the following command:

"J0700" in text or "4a 30 37 30 30 0d" in hex.

Answer will be:

"4b 30 37 30 30 20 30 30 44 35 0d" in hex, "K0700 00D5" in text, 00D5h > 11010101 in bin > Device is powered on, stopped, internal current set, internal enable, denied external NTC Interlock, denied Interlock.

To set new state, for example, allow Interlock, send the following command:

"P0700 1000" in text, "50 30 37 30 30 20 31 30 30 30 0d" in hex.

4) Errors:

If a command with the wrong parameter number was sent, answer will be "K0000 0000" ("4b 30 30 30 30 20 30 30 30 30 0d").

If a command with the wrong format was sent, answer will be an error "E0001" ("45 30 30 30 31 0d").



Fig. 10 – Screenshot from the Termite terminal with commands and answers

The maximum duration depends on the set value of the frequency. When you change frequency, a new value of the maximum duration is compute automatically. The duration of pulse cannot be less than 2 ms and more than period of frequency minus 2 ms. For low frequencies the duration cannot be more than 5000 ms.

Set the zero frequency to switch the device into CW mode or set not zero frequency value to switch the device into QCW (long pulses) mode. If you try to set a value more or less than limits, then the value will be rounded to limit. Any attempts to set a new state of the device, except “start”, forcibly switch the device to the state “stop”. Some states of the device are mutually exclusive, for example, if you set “Ext. Enable”, then you will not be able to set the state “start”. If you send “start” and “stop” commands to each other, the device will save all parameters in the internal memory. The saving process lasts about 300 ms. In this time the device does not respond to any actions. The device is able to save the next parameters in the internal memory:

- Frequency with limits;
- Duration with limits;
- Current with limits and calibration;
- Temperature limits and $B_{25/100}$;
- Settings of the RS protocol extension (see section «Digital control description (extended)»).

24. Digital control description (extended)

WARNING! *Extended protocol recommend for advanced users only. In addition, it might be use for integration of the device with other devices.*

Use the parameter number 0704h for configure the extended protocol. In extended protocol, you can enable and disable the next options: checksum (CRC 8-bit CCITT), return a new value of parameter after P-type commands, change baud-rate, change protocol-mode (text-plain or binary).

The description of the protocol extension command

Action			R\W	HEX-number of parameters
Information about the extended protocol	0 bit	1 – the device supports this option	R	0704
	1st bit	Checksum (1 – on, 0 – off)		
	2nd bit	Return a new value for P-type commands (1 – on, 0 – off)		
	3-5 bits	Baud - rate 0 – 2400 1 – 9600 2 – 10417 3 – 19200 4 – 57600 5 – 115200 (default)		
	6th bit	Data exchange mode (1 – binary, 0 –text-plain)		
Configuring of the extended protocol	On checksum (CS)	0002h ⁶	W	0704
	Off checksum	0004h ⁶		
	Return a new value for P-type commands	0008h ⁶		
	Do not return answer for P-type commands	0010h ⁶		
	Set new baud-rate(baud) ⁷	0100h – 2400 0120h – 9600 0140h – 10417 0160h – 19200 0180h – 57600 01A0h – 115200		
	Binary mode on ⁸	0200h		
	Text-plain mode on	0400h		

⁶ In binary mode the specified commands are ignored by the device.

⁷ Here are binary numbers.

⁸ For more information, see section “binary mode”.

Text-plain mode

All commands in text-plain mode should be in ASCII.

WARNING! *If you enable the checksum it will change format of commands. After <CR> symbol you will be write 2 bytes of checksum and last byte will be <LF> (0Ah – “new line” symbol). Checksum is computed for all bytes of command before checksum bytes (including<CR> symbol).*

All answers of the device will also contain a checksum, including K-type and E-type answers. Checksum is computed by CRC-CCITT-8 algorithm. This is the main difference between the format of commands for the extended protocol and standard protocol.

The format of commands for enabled checksum

Number of byte	Value	Comment
1	P,J,K,E	Type of command
2-5	Number of parameter	Hex-number of value
6	'space' symbol (20h)	<i>(does not use for J and E-type commands)</i>
7-10	New value of the parameter	Hex-value of parameter <i>(does not use for J and E-type commands)</i>
11	'return carriage' symbol<CR> (0Dh)	End of value
12-13	Checksum	CRC checksum of the first 11 bytes <i>(for J and E-type commands checksum is computed for the first 6 bytes)</i> , including <CR> symbol.
14	'new line' symbol<LF> (0Ah)	End of command

Possible problems

1. The device waiting for symbol <LF>. If <LF> symbol does not received and buffer is overflowed, then all symbols after overload will be processed as a new command. The device returns an error. In this case, it is recommended to send the <LF> symbol. The device will generate an error and clear the buffer for the next command.
2. All symbols after the <LF> symbol will be processed as a new command.

Binary mode

The binary mode has a significant difference. In this mode, data are exchanged in binary form. Length of any type of command is 8 bytes! In this mode, next options are always enable and you cannot disable it: return a new value of parameter for P-type commands and checksum. The format of binary mode commands is represented in table 8.

The format of binary mode commands

Number of byte	Value	Comment
1	Type of command	50h (P - ascii) – Set a new value of parameter 4Ah (J - ascii) – Get a value of parameter 4Bh (K - ascii) – Answer of the device 45h (E - ascii) – Error
2-3	Number of parameter	Hex-number of parameter
4-5	Value of parameter	Hex-value of parameter. This value is STRICTLY REQUIRED in the binary mode. If this value does not make sense, it will be returned as 0000 (K or E-type commands) or you should set it field to any value (for P or J-type commands).
6	‘return carriage’ symbol <CR> (0Dh)	End of value
7	Checksum	CRC checksum of the first 11 bytes (<i>for J and E-type commands checksum is computed for the first 6 bytes</i>), including <CR> symbol.
8	‘new line’ symbol <LF> (0Ah)	End of command

25. Troubleshooting guide

Problem	Potential causes	Solution
Driver doesn't turn on – OR – There is no output	The device is in the locked state	The driver and the temperature controller can only be turned on with shorted Interlock. For more details see paragraph 18.1.
		The device will not work if thermistor is unplugged. This situation may occur if you connect dummy load without thermistor. For more details see paragraph 18.2.
	Incorrect pinout of the laser diode	Check if the laser diode pinout is match to driver model. For more details see paragraph 15.
	Onboard switch were set to ON before power up the device	Please power up the device with switches OFF and unconnected pins 2, 3 of analog control connector. For more details see paragraphs 18.6 and 18.7.
An error is triggered when the driver is turned on	The current protection threshold is too low	Change the current protection threshold of the driver. For more details see paragraph 18.4.
	The driver is turned on at high current with a driver short installed	When the driver is turned on at high current with a driver short installed, a current surge may occur. Due to this surge the protection is triggered. Use the driver short jumper to configure driver with required values. Remove this jumper before turning on the driver.

26. Mechanical dimensions

All dimensions are in millimeters. Contact us via www.LaserDiodeControl.com for a 3-D CAD model of the laser driver package.

26.1. SF8xxx-10 model for soldering 10-pin Butterfly

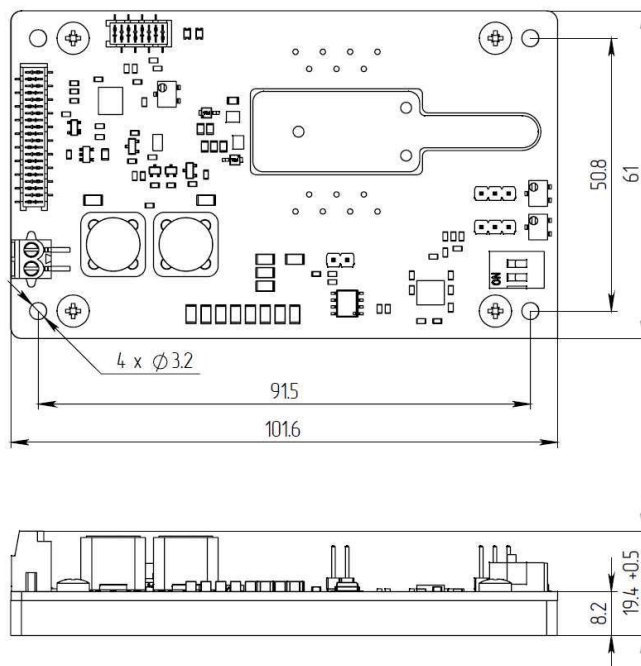

26.2. SF8xxx-14 model for soldering 14-pin Butterfly

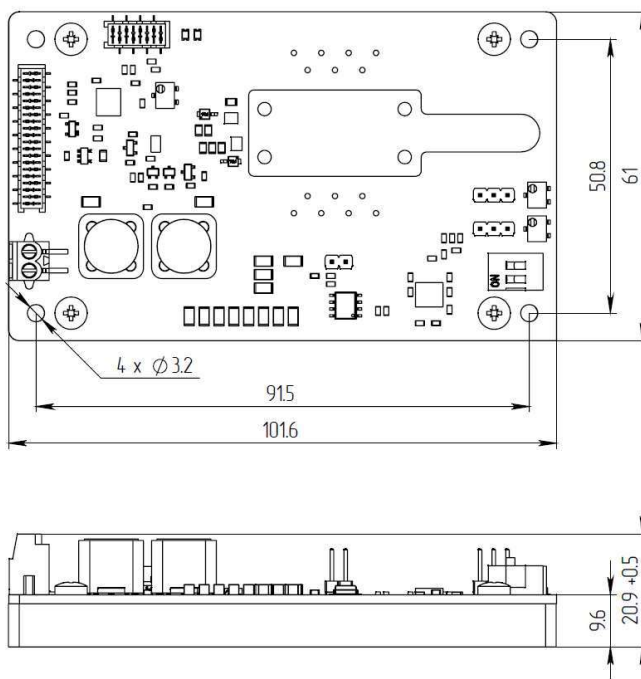

26.3. SF8xxx-ZIF10 model with Azimuth connectors for 10-pin Butterfly

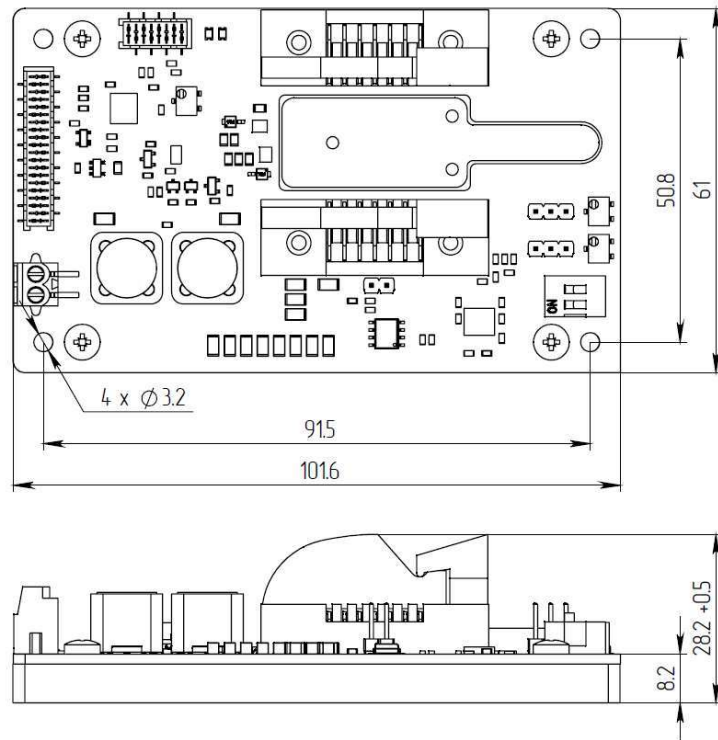

26.4. SF8xxx-ZIF14 model with Azimuth connectors for 14-pin Butterfly

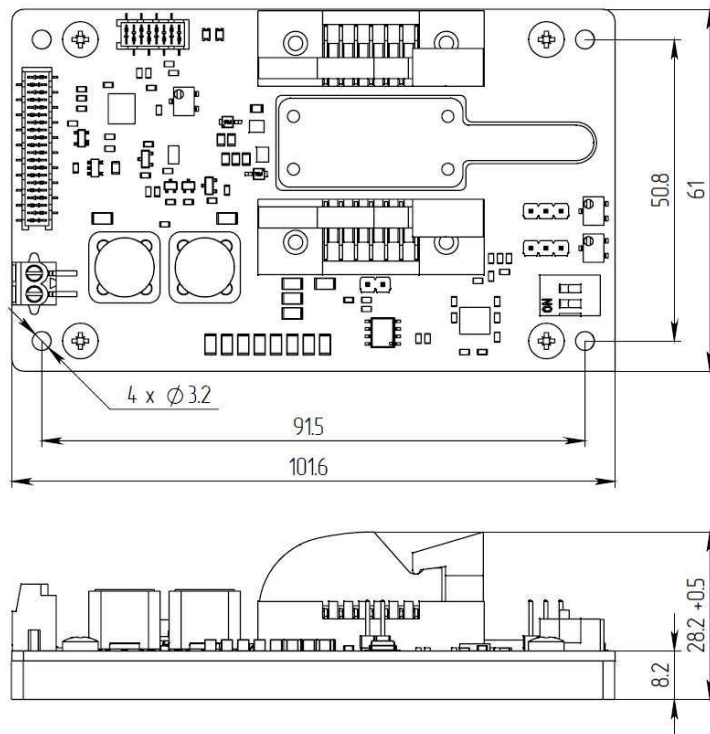

27. Warranty

In compliance with the provisions of Conditions limited warranty the Buyer has the right to guarantee during the one year period. The warranty period comes into effect from the shipping date.

The warranty only concerns products that are applied according requirements and for the applications specified in the manual for the product. If you want to use the products for other applications, contact us to discuss the implications to the warranty. This warranty does not apply to damage due to incorrect use, abnormal use, or use in violation of product manual.

PRODUCT WARRANTY:

This product is sold with a full one year warranty. It is warranted to be free from defects in material and/or workmanship for a period of one year from the date of shipment. The warranty does not include damage to the product due to customer mishandling or use of the product outside of its specified maximum ratings.

INSTALLATION SUPPORT OR TECHNICAL SUPPORT FOR THIS PRODUCT:

800-887-5065 extension 1
contact@laserdiodecontrol.com



Part of the Laser Lab Source Group:
LaserLabSource.com
LaserDiodeSource.com
LaserDiodeControl.com
Laser Diode Technologies

Laser Lab Source Inc.
1820 W. Lincoln Street
Bozeman, MT USA 59715
contact@LaserDiodeSource.com
contact@LaserDiodeControl.com
800-887-5065

800-887-5065