

*This product is sold
and supported
in the USA by*



LASER LAB SOURCE
marketplace for **Scientists & Engineers**

contact@LaserLabSource.com

800.887.5065

OEM TEC Controller



RoHS
COMPLIANT

The TEC-1089 is a specialized TEC Controller / power supply able to precision-drive a single Peltier element.

It features a true bipolar DC current source for cooling / heating, two temperature monitoring inputs (1x main, 1x auxiliary) and intelligent PID control with auto tuning. The TEC-1089 is fully digitally controlled, its hard- and firmware offer numerous communication and safety options.

The included PC-Software allows configuration, control, monitoring and live diagnosis of the TEC Controller via USB and RS485. All parameters are saved to non-volatile memory. Saving can be disabled for bus operation.

For the most straightforward applications, only a power supply, Peltier elements and two temperature sensors need to be connected to the TEC-1089. After power-up the unit will operate according to pre-configured values. (In stand-alone mode no control interface is needed.)

The TEC-1089 can handle either Pt100, Pt1000, NTC or Voltage temperature probes. For highest precision and stability applications a Pt100 / 4-wire input configuration is recommended. Analog measurement circuit is factory calibrated.

Auxiliary temperature input allows the connection of an NTC probe that is located on the heat sink of the Peltier element. This additional data is used to compensate for parasitic thermal conduction of Peltier element. Also, it allows the control of an external heat sink cooling fan.

The heating and cooling power is optimized by proprietary thermal management routines based on power balance models (for Peltier elements and resistive heaters).

Further functionality includes: Smooth temperature ramping, thermal stability indication and auto gain (NTC probes). The PC-Software allows data logging and configuration import/export.

Many features (hardware, software) of this OEM product are customizable upon request.

Features

Output Stage:

- Output Current: 0 to ± 10 A, <1% Ripple (0 to ± 16 A available as TEC-1090)

-SV (Standard Voltage) Version (stock item, recommended):

- DC Input Voltage: 12 – 24 V
- Output Voltage: 0 to ± 21 V (max. $U_{IN} - 4$ V)

Main Features:

- Temperature Sensor Types: Pt100, Pt1000, NTC, Voltage
- Temperature Precision / Stability: <0.01 °C
- Temperature Control & Measurement Frequency: 1 Hz, 10 Hz, 80 Hz
- Performance-optimized PID for Thermal Power Control
- Configuration / Diagnosis over USB / RS485 PC Software
- Dimensions (L x W x H): 75 mm x 60 mm x 18 mm
- Efficiency: 95% (@ 90% Load)
- Cooling over Base Plate
- Auxiliary Peltier Heat Sink NTC Temp. Sensor Input

Operation Modes:

- Stand-Alone without Live Control Interface
- Remotely-Controlled over USB, RS485, RS422, I/O
- Script-Controlled over Lookup Table Read-Out

Driver Modes:

- DC Power Supply: Set Current or Voltage
- Temperature Control: PID Settings, Auto Tuning, optional Cool/Heat-Only or Resistor modes

Data Interfaces:

- USB 2.0 1 kV isolated (FTDI Chip)
- 2x RS485 / RS422

General Purpose I/O Features:

- 4x Digital I/O Signals (3.3 V / 5 V)
- Configurable as Input to control TEC-1089 (Enable, Temperature Up / Down etc.)
- Configurable as Output to monitor TEC-1089 (Error Indication, Temperature Stable Indication etc.)

Optional Components:

- Various displays available up to 4x20 Chars (DPY-1113)

Further Information:

- Please contact us for additional information or consult the current TEC Controller User Manual (Document 5216).
- The TEC-1089 is part of the TEC-Family of Meerstetter TEC Controllers. It is designed to operate alongside devices of the LDD-Family of laser diode drivers. Both families of drivers share the same system bus, design, technology and physical dimensions.

Absolute Maximum Ratings

| | |
|---------------------|------------|
| Supply voltage (DC) | 27 V (-SV) |
|---------------------|------------|

| | |
|------------------------|-------------|
| Bipolar output voltage | ±26 V (-SV) |
| Bipolar output current | ±14 A |

Operating Characteristics for Firmware >= v4.00

| | |
|-------------|-------------------------|
| Temperature | -40°C to 90°C |
| Humidity | 5 – 95%, non-condensing |

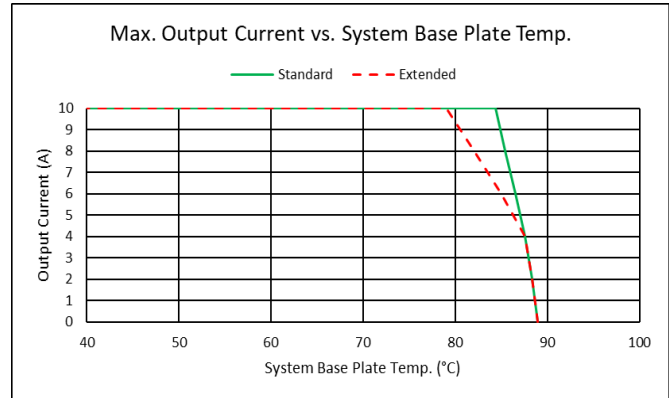
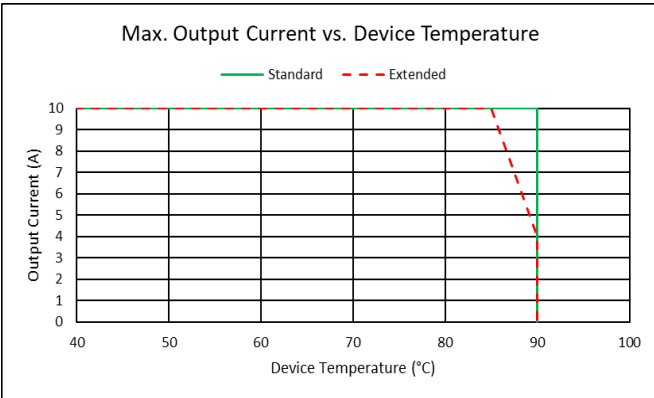

Additional information about the charts above:

- Standard or Extended device temperature mode can be set as a software setting.
 - In standard mode, the device throws an error and switches off if the maximal device temperature is reached.
 - In extended mode, the device first reduces the maximum output current before it throws an error and switches off.
- The Device Temperature is the temperature which is being measured by the TEC Controller itself on its own PCB. This is the temperature which is relevant for the overtemperature behavior (left chart).
- The System Base Plate is assumed as the customers heatsink where the TEC Controller is mounted to. The right diagram shows the maximum temperature of the customers heatsink to not exceed the temperatures in the left diagram under the following conditions:
 - Between the TEC Controllers base plate and the customers heatsink this thermal pad: Bergquist: "GP1500R-0.010-02-0816" was used. We recommend employing this or a similar product.
 - The TEC Controller is pressed with 1.2kPa to the System Base Plate. It is recommended to use the mounting holes of the TEC Controller to press the TEC Controller to the System Base Plate.
 - The air ambient temperature was approximately 30°C colder than the System Base Plate.

Operating Characteristics for Firmware < v4.00

| | |
|-------------|-------------------------|
| Temperature | -40 – 85°C |
| Humidity | 5 – 95%, non-condensing |

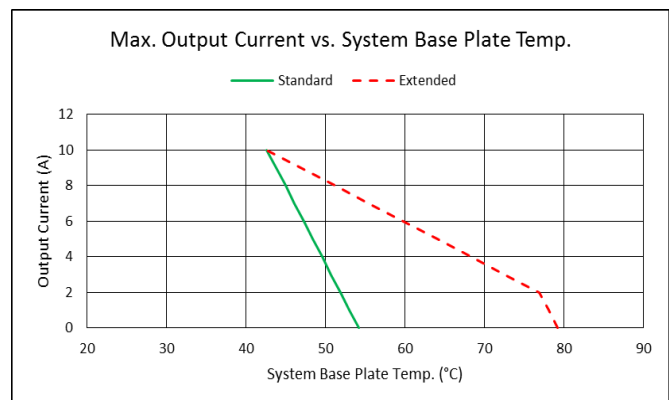
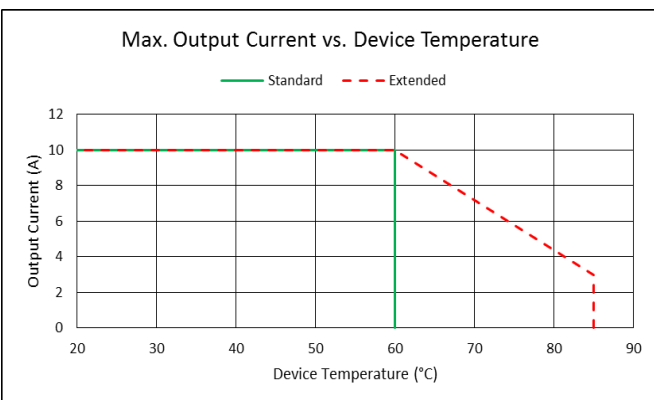

Test Condition:

TEC Controller pressed with 1.2kPa to an aluminum System Base Plate without any thermal conductivity material in between. Using a good thermal conductivity material is recommended for high output currents.

Standard or Extended Device Temperature Mode can be set as software setting.

Electrical Characteristics for SV (Standard Voltage) Version

Unless otherwise noted: $T_A = 25^\circ\text{C}$, $U_{IN} = 24\text{ V}$, $R_{load} = 1.75\ \Omega$, $FW \geq v4.00$

| Symbol | Parameter | Test Conditions | Min | Typ | Max | Units |
|--|-----------------------|---|------|-----|----------|------------------|
| DC Power Supply Input: | | | | | | |
| U_{IN} | Supply voltage | Measured directly on power input terminals | 11.5 | 24 | 25.5 | V |
| U_{IN} Ripple | Ripple tolerance | | | | 300 | mV _{PP} |
| Output (per Channel): | | | | | | |
| I_{OUT} | Bipolar current swing | | | | ± 10 | A |
| U_{OUT} | Bipolar voltage swing | U_{IN} at least 4 V greater than U_{OUT} Measured directly on power output terminals | | | ± 21 | V |
| U_{OUT} Ripple | Voltage ripple | $I_{OUT} = 10\text{ A}$ | | 90 | | mV _{PP} |
| System Characteristics: | | | | | | |
| $\eta_{50\%}$ | Power efficiency | @ 50% load (10.5V, 10A) | | 93 | | % |
| $\eta_{100\%}$ | Power efficiency | @ 100% load (21V, 10A) | | 96 | | % |
| Output Monitoring (I_{OUT} Resolution is 7.3mA; U_{OUT} Resolution is 8.8mV) | | | | | | |
| I_{OUT} Read | Precision | @ 9.5 A | | 1 | 5 | % |
| U_{OUT} Read | Precision | @ 15.0 V | | 1 | 3 | % |
| Input Reverse Polarity Protection: (GND input is connected through a Power MOSFET which is not active when reverse polarity is applied to the power supply terminals.) | | | | | | |
| U_{IN} Pol. | Reverse polarity | | | | -27 | V |

Output Safety Characteristics

Unless otherwise noted: $T_A = 25^\circ\text{C}$, $U_{IN} = 24\text{ V}$

| Symbol | Parameter | Test Conditions | Min | Typ | Max | Units |
|--|-----------------|----------------------------|-----|-----|-----|---------------|
| Output Stage Protection Delays: | | | | | | |
| t_{OFF} Short circuit | | Full load condition | | 10 | 30 | μs |
| t_{OFF} Power system limits | | Current and voltage limits | | | 200 | μs |
| Output Stage Current Supervision: (If the $OUT+$ and $OUT-$ currents differ too much, an error is generated) | | | | | | |
| I_{OUT_DIFF} | Error threshold | | | 1 | | A |

Object Temperature Measuring Characteristics (Pt100 and Pt1000 Probes)

Measurement configuration = 23bit / 4-wire / unshielded cable <50mm

| Symbol | Parameter | Test Conditions / Hints | Min | Typ | Max | Units |
|------------------|-------------------|---|------|-------|------|---------------------------|
| $T_{OBJ, RANGE}$ | Range | Range is extendable upon request Default measurement range is $-220^\circ\text{C} \dots +200^\circ\text{C}$ Extended measurement range is $-193^\circ\text{C} \dots +787^\circ\text{C}$ | -100 | | +200 | $^\circ\text{C}$ |
| $T_{OBJ, PREC}$ | Precision | (EN 60751 / IEC 751) | | 0.005 | 0.01 | $^\circ\text{C}$ |
| $T_{OBJ, COEFF}$ | Temp. Coefficient | Relative to device temperature | | | 1.6m | $^\circ\text{C}/\text{K}$ |
| $T_{OBJ, NOISE}$ | Value Noise | Reference measurement fluctuations while output stage operating @70% load | | 0.003 | | $^\circ\text{C}$ |
| $T_{OBJ, REP}$ | Repeatability | Repeated measurements of reference resistors after up to 3 days | | 0.005 | | $^\circ\text{C}$ |

Object Temperature Monitoring Configurations (NTC Probes)

NTC thermistor resistive input characteristics translate into temperature ranges valid for only one type of NTC probe. Below example is given in the case of an NTC B_{25/100} 3988K R₂₅ 10k temperature sensor.

| Symbol | Parameter | Test Conditions | Min | Typ | Max | Units |
|-------------------------|-------------------------------|--|------|----------------|-------|---------|
| R _{OBJ, RANGE} | ADC Gain PGA = 1 | Low-°T Configuration NTC56K Corresponding temperature range | 3360 | 51.8 to -10.1 | 55720 | Ω °C |
| | | High-°T Configuration NTC18K Corresponding temperature range | 135 | 164.0 to 12.2 | 17910 | Ω °C |
| R _{OBJ, RANGE} | ADC Auto Gain PGA = 1 or 8 | Mid-°T Configuration NTC39K Corresponding temperature range | 293 | 131.0 to -3.4 | 38805 | Ω °C |
| | | Very Low-°T Configuration NTC1M Corresponding temperature range | 293 | 131.0 to -55.5 | 1M | Ω °C |

R_{OBJ, RANGE} is resistance range of the NTC sensor

Object Temperature Monitoring Configuration (Voltage Measurement VIN)

Sensors with linear Voltage/Temperature output.

| Symbol | Parameter | Test Conditions / Hints | Min | Typ | Max | Units |
|-------------------------|-----------|--|--------|-----|-------|-------|
| V _{SENS, DIFF} | Range | Differential Input voltage Temperature range depends on sensor used | -2.039 | | 2.039 | V |
| V _{OBJUX, ABS} | Range | Absolute Input voltage | 0.1 | | 3.2 | V |

Sink Temperature Measuring Characteristics (NTC only)

T_A = 25°C, measurement configuration = 12bit / 2-wire / unshielded cable <50mm, °T probe = NTC B_{25/100} 3988K R₂₅ 10k

| Symbol | Parameter | Test Conditions / Hints | Min | Typ | Max | Units |
|--------------------------|-----------|---------------------------------|-----|-------------|-------|---------|
| R _{SINK, RANGE} | Range | Corresponding temperature range | 180 | 150 to -6.0 | 44600 | Ω °C |

General Purpose Digital I/O Characteristics (GPIO1 ... GPIO4)

Unless otherwise noted: T_A = 25°C, U_{IN} = 24 V

| Symbol | Parameter | Comments | Min | Typ | Max | Units |
|---|----------------------------|--------------------|------|-----|------|-------|
| Input Characteristics: | | | | | | |
| U _{IH} | Logic high input threshold | | 2.38 | | | V |
| U _{IL} | Logic low input threshold | | | | 0.93 | V |
| U _{IMAX} | Maximum input voltage | | -0.5 | | 5.5 | V |
| Output Characteristics: (Microprocessor) | | | | | | |
| U _{OH} | Logic high output voltage | Output current 8mA | 2.8 | | | V |
| U _{OL} | Logic low output voltage | Input current 8mA | | | 0.4 | V |
| ESD Protection: (Between Processor and Connector) | | | | | | |
| V _{PP} | ESD discharge | IEC61000-4-2 | | | 100 | kV |
| R _A | Series resistance | | 170 | 200 | 230 | Ω |

Package Outline and Pin Configuration

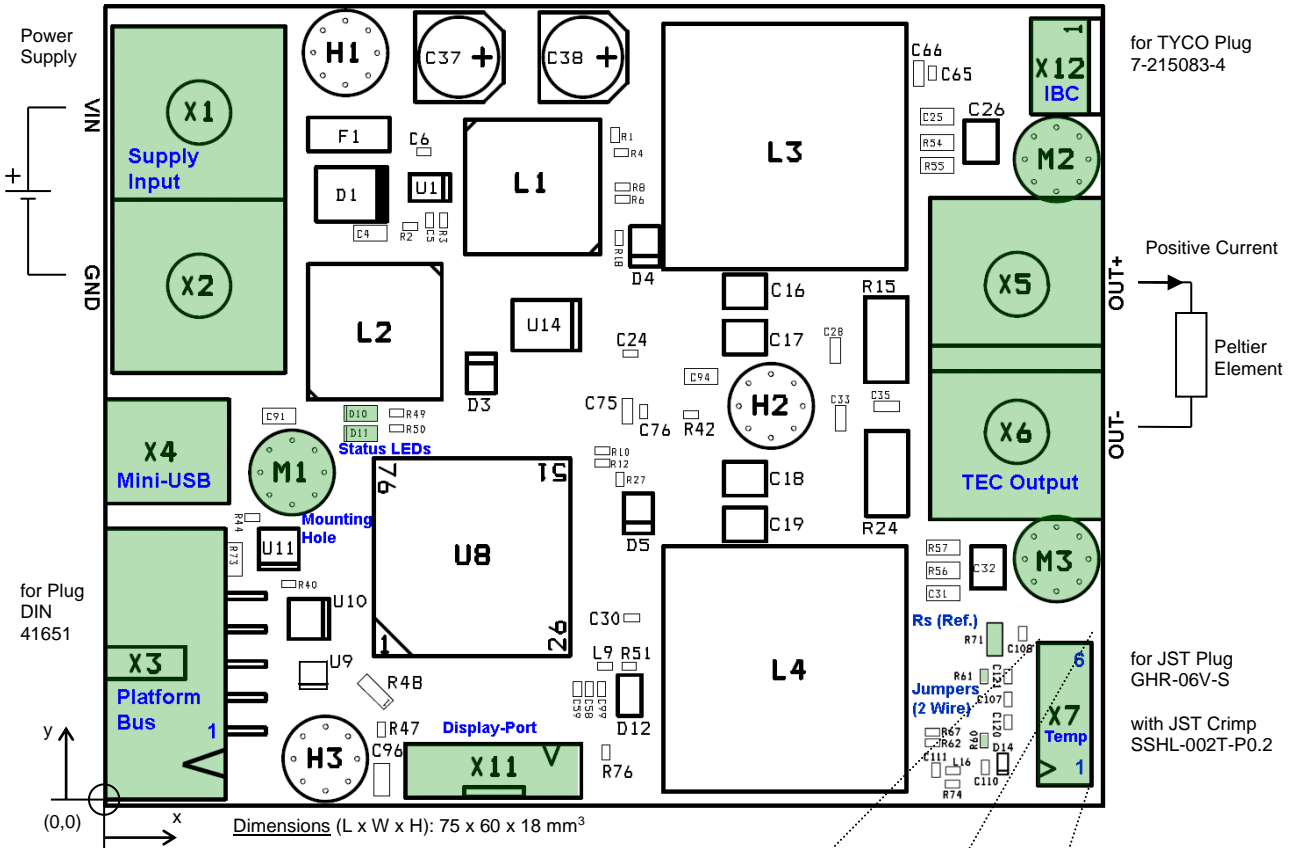

Mounting (3x 3.2mm Holes, 7.6 mm in Length):
 M1: x = 14.0 mm, y = 25.0 mm
 M2: x = 71.5 mm, y = 48.5 mm
 M3: x = 71.5 mm, y = 18.5 mm

Power Terminals: M4-size Screws

Pin Descriptions Platform Bus X3:
 1: VIN Output (fused with polyfuse 200mA; -HV is 100mA)
 2: GND (fused with polyfuse 200mA; -HV is 100mA)
 3: RS485_A1 (D+) [*R72 = Termination (120Ω), N.A.]
 4: RS485_B1 (D-) (*R72 not accessible from top)
 5: RS485_A2 (D+) [R73 = Termination (120Ω), N.A.]
 6: RS485_B2 (D-)
 7: GPIO1
 8: GPIO2
 9: GPIO3
 10: GPIO4

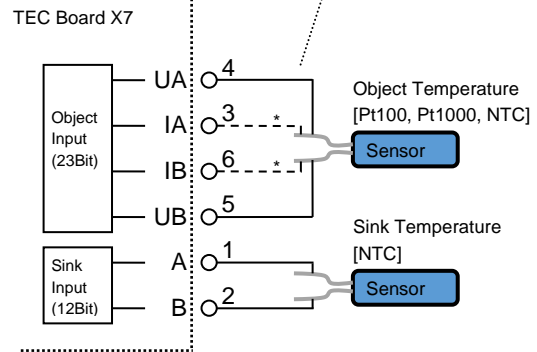

* In case of Pt100 or Pt1000, use 4 wires to connect the Object Temperature Sensor

Peltier element, temperature probes, power supply and connectors not included.

Operation-Modes and Communication Options

The TEC-1089 is an OEM precision TEC Controller that is primarily designed to operate as a stand-alone device. Once configured and in operation, its basic status is visually indicated by on-board green and red LEDs and their blinking pattern. More detailed status information can be polled at any time by industry-standard RS485 connection or by USB (see box below). The TEC-1089 can also operate in a remotely-controlled manner, with parameters adjusted on the fly. The latest firmware upgrade introduced scripting capability by sequential lookup table read-out.

Configured as a DC power-supply, the TEC-1089 can handle current and voltage settings. In the remote-control case, temperature data may be passed on to be processed by the host.

Configurable parameters further include: sensor linearization (Pt100 / Pt1000) and Steinhart-Hart modeling (NTC), temperature acquisition hardware calibration, Peltier element modeling, PID controller auto tuning, nominal temperature ramping, current, voltage and temperature limits, error thresholds, etc. Please refer to the TEC Controller User Manual (Document 5216) for further information.

TEC Service Software

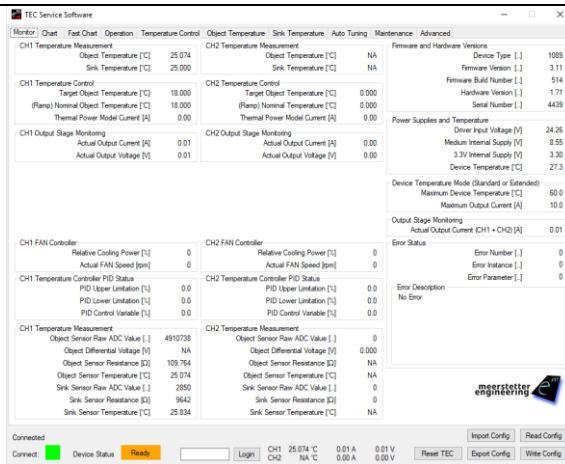

The included TEC Service Software is a powerful tool that allows monitoring, data logging and full configuration of the TEC-1089 via a standard USB or an RS485 connection from a PC running Windows.

This tool is ideal for laboratory setups, product evaluation and commissioning. In conjunction with the comprehensive set of error codes and built-in descriptions, it facilitates diagnosis and debugging.

The software also supplies a user-friendly interface for maintenance (e.g. firmware upgrades), device calibration and basic data logging.

Please refer to the user manual for more information on features and system requirements.

Temperature Control (Autotuned PID)

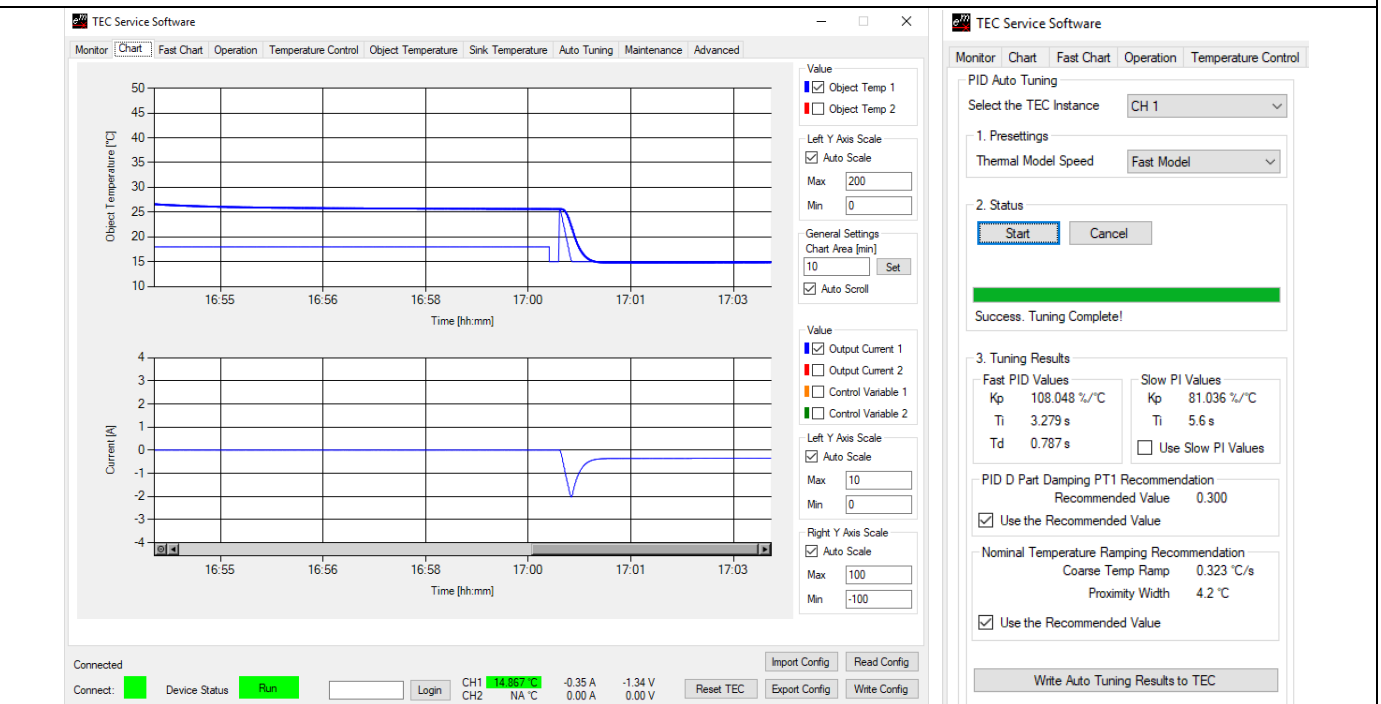

TEC-1089 Ordering Information, Hardware Configuration

Example Configuration: **TEC-1089-SV-PT100**

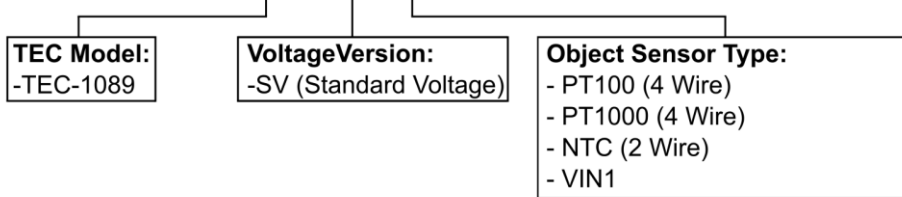

Object Sensor Type:

NTC: By default we mount an NTC1M. If you require an older version (NTC18K, NTC39K or NTC56K), please write which one you need in the comment section of your order or contact us: contact@meerstetter.ch

Thermocouple: To use our TEC Controller with thermocouples type K, you need a TCI-1181 in addition to the TEC Controller with a VIN1 Object Sensor Type configuration.

Display Unit:

It is possible to connect a small or big OLED 2x16 / OLED 4x20 character display directly to the X11 connector. Please visit the DPY-1113 product web page for further information.

Customization:

Many hardware and software features of the TEC-1089 are customizable upon request. Please contact Meerstetter Engineering with your enquiry.